



USER MANUAL



Contents

Introduction.....	2
Important Safety Instructions.....	4
Product Overview.....	5
Installation.....	10
Front Panel Functional Descriptions.....	16
Starting the SR Series Inverter.....	17
The Communications Interface.....	23
Inverter Status Diagnostics and Repair.....	26
Specifications.....	30

Introduction

Thank you for buying this Sunny Roo Series Inverter. Many years of design experience has gone into the construction of this device, and your Sunny Roo Series Inverter should give your solar power system many years of trouble-free operation.

Your new Inverter is a complex electronic system, and over its life-time it will be confronted with a variety of local conditions. If a malfunction of your Sunny Roo Series Inverter occurs, please contact your specialised dealer directly. Your dealer will assist you or will refer you to someone who can help with your query.

Please read this User Manual carefully to familiarise yourself with your new device. Please pay particular attention to information regarding the installation and commissioning of your Sunny Roo Series Inverter.

Important Safety Instructions

General



Warning! Incorrect operation and/or work performed can cause serious injury and damage! Only qualified personnel are authorised to install your SR Series Inverter; installation should be carried out within the scope of the respective technical regulations. Do not start operation or carry out maintenance work before reading the chapter 'Important Safety Instructions'.

This manual contains important instructions for the Sunny Roo Series SR 1500TL, 2000TL, 3000TL, 4200TL, 5000TL that should be followed during installation and maintenance of the inverters.

Housing



Warning! These servicing instructions are for use by qualified personnel only. To reduce the risk of electric shock, do not perform any servicing other than that specified in the operating instructions unless qualified to do so.

Only qualified installers are authorised to open the connection area. Do not open the connection area when the inverter is under load (ie. ensure power is not running through inverter).

Only trained service staff may open the upper portion (power stage) of the SR Series Inverter, and only when the inverter is not under load.

Repair

Only trained service staff are authorised to carry out repairs to the SR Series Inverter unit.

PV Module

Before connecting the solar modules, you must check whether the voltage parameters specified in the manufacturer's data correspond with the actual parameters. When checking the voltage reading, please take into account that solar modules supply a higher no-load voltage when temperature is low and sunlight level remains unchanged. At 14°F (-10°C) the open-circuit voltage of the PV modules must never exceed 500V. The data sheet of the solar module will tell you the temperature factors applicable for determining the theoretical open-circuit voltage at 14°F (-10°C). If the solar modules exceed an open-circuit voltage of 500V, the SR Series Inverter may be damaged. In these circumstances all warranty rights will be void.

The SR Series Inverter includes a Residual Current Monitoring Unit (RCMU) according to VDE0126-1-1. This device measures the Earth current of the PV array and will prevent the inverter from feeding the grid in the case of an Earth fault.

Grid Connection

Only appropriately licensed contractors are authorised to connect the SR Series Inverter to the grid. Consult your local authorities for specific requirements. Before connecting the SR Series Inverter to the grid, permission for the connection must be granted by the utility company.

Product Overview

External Dimensions



Module number Dimensions (mm)	SR1500TL, SR2000TL, SR3000TL	SR4200TL, SR5000TL
L	455	455
H	430	510
D	170	170

Unit Description

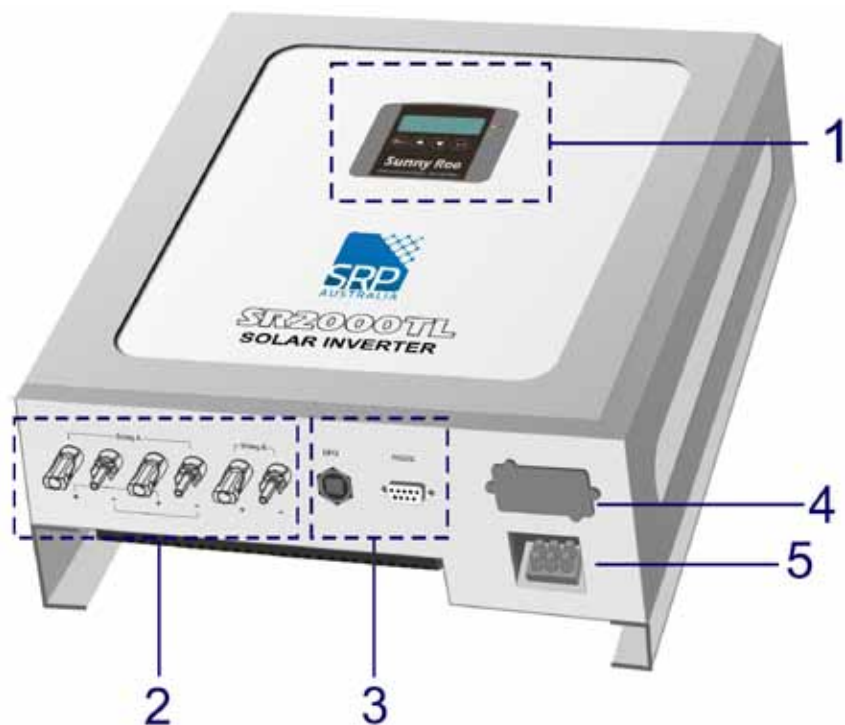

1. **LCD & LED Display:** Shows the operation information and status of the inverter.
2. **Solar Array Input:** Plug-and-play connector terminals for the connection of the solar modules (The SR1500TL/2000TL/SR3000TL only have one PV string input).
3. **Standard Communication Port :** EPO & RS232.
4. **Optional Communication Slot:** USB, RS485, Dry Contact, TCP/ IP.
5. **AC Output Terminal:** AC output for the utility supply.

Installation

Please read 'Important Safety Instructions' (page 3 & 4) before installing the SR Series Inverter.

Unpacking

Inspect the SR Series Inverter upon receipt. If damage has occurred during shipment please notify your specialised dealer immediately. The inverter packaging is recyclable, we encourage you to re-use it or dispose of it properly.

Remove the SR Inverter from its box. Check the package contents.

Standard contents should include:

- ✓ 1 set of accessories
- ✓ 1 data CD-ROM
- ✓ 1 Mounting Frame Accessory Kit (shown below):

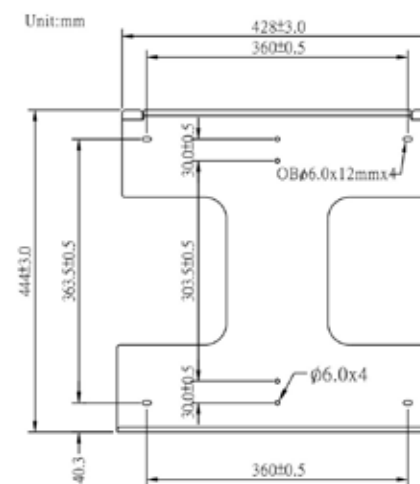

SR4200TL/5000TL

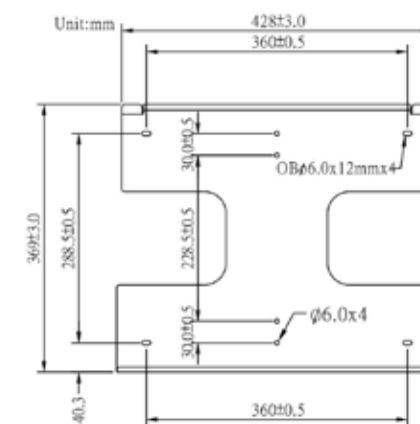

SR1500TL/2000TL/3000TL

Installation Requirements

The SR Series Inverter is heavy. Take this weight into consideration when choosing the installation site and method of installation.

To ensure proper operation and long operating life, always position the SR Series Inverter according to the following requirements:

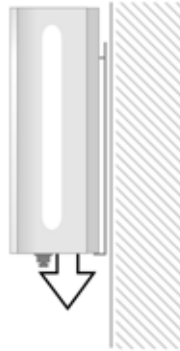

SR1500TL/2000TL/3000TL 23Kg
SR4200TL/5000TL 28Kg



(1) The SR Series Inverter is designed for outdoor installation, and should be installed away from direct sunlight. Increased ambient temperatures and/or installation in poorly ventilated and warm indoor locations may reduce the yield of the PV system. The optimum ambient temperature lies within the -25°C to +50°C range.

(2) The SR Series Inverter is designed to be mounted on a vertical wall. If installing the unit outdoors, make sure that it is not slanting forward. We advise against installing the unit in a horizontal position.



Install the inverter vertically or tilting backward.

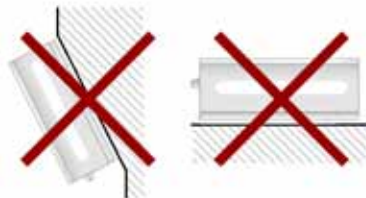

Never install the inverter horizontally or so that it tilts forward.

(3) When choosing the installation site, ensure there is enough space for heat dissipation. Under normal conditions, installers should adhere to the following guidelines regarding space to be left clear around the inverter:

	Minimum Clearance
Sides	20 cm
Top	20 cm
Underneath	20 cm
Front	5 cm

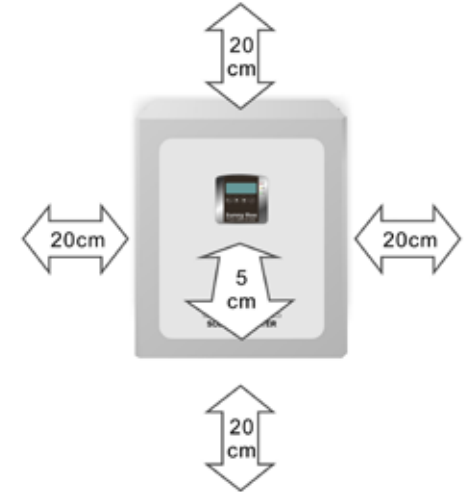

Mounting the Unit

We recommend that you use the supplied wall mounting bracket to mount the SR Series Inverter. For vertical installation and installation on solid concrete or block walls, be sure to take into account the weight of the inverter when selecting the mounting materials.

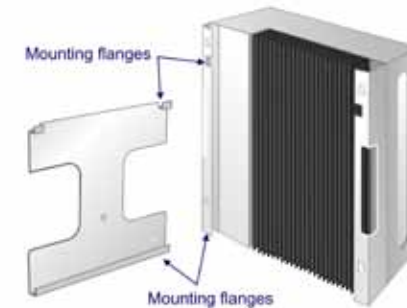

If you do not want to use the supplied wall mounting bracket, refer to the dimensions shown in the drawing above. The procedure for mounting the inverter using the wall mounting bracket is described on the following pages.

Installation: Step by Step

Step 1. Fit the wall mounting bracket. When marking the positions of the drill holes, use the wall mounting bracket as a drilling template.

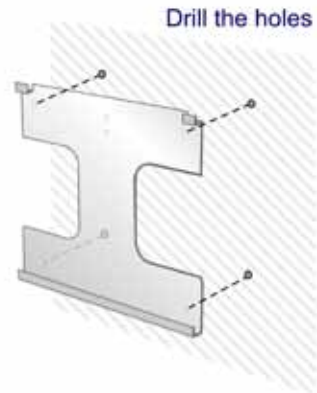

Step 2. Hang the SR Series Inverter onto the wall mounting bracket using its upper mounting plate. This ensures the inverter cannot be moved sideways.

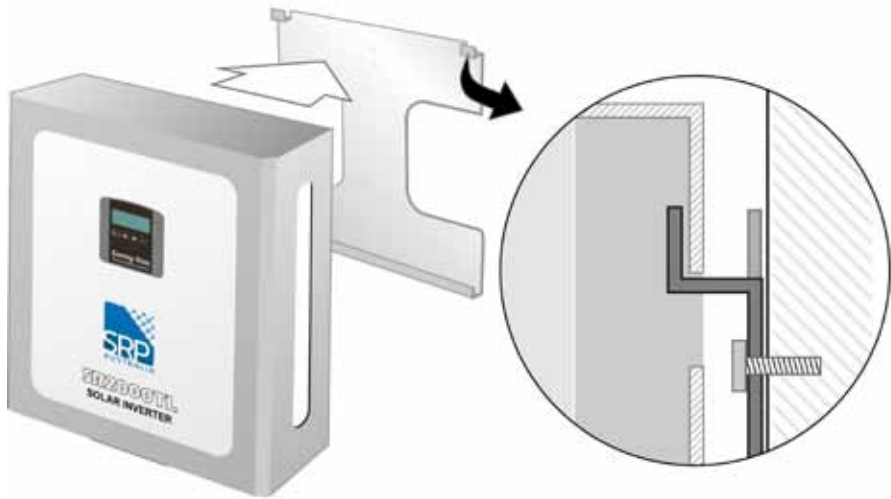

Step 3. Check that the SR Series Inverter is positioned securely on the bracket.

Electrical Installation

The correct installation for the SR Series Inverter is shown in the following diagram below (Fig. 1)

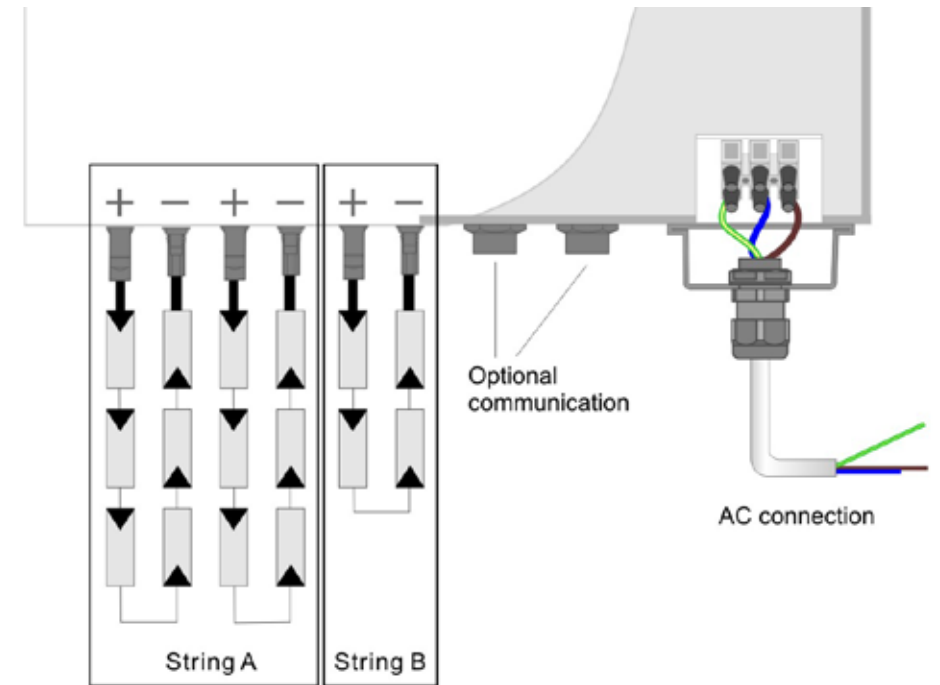

Fig. 1

Connecting to the Grid (AC utility)

To connect the AC cable, proceed as follows:

Step 1. Measure the voltage and frequency of the Grid/Utility.
The voltage and frequency of the Grid/Utility will differ between countries.

Step 2. Before wiring the SR Series Inverter, ensure the main breaker in the primary utility breaker box is switched to OFF. Switch this breaker to ON only after all wiring has been completed as instructed in this User Manual.

Step 3. Remove the screws that secure the case of the SR Series Inverter and carefully remove the cover. Remove the connection from the cover as shown in Fig. 2.

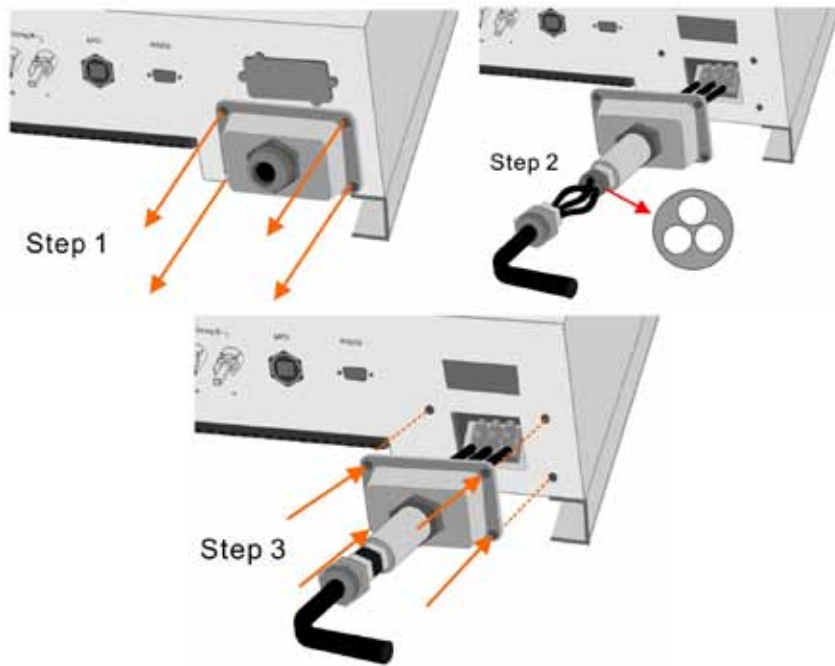

Fig. 2

Step 4. Insert utility wires through cable gland. Connect wires according to polarities indicated on terminal block.

L1 means LINE1 (black), N means Neutral (White), L2 means LINE2 (Red), E means system Earth (yellow-green) as shown in Fig. 3

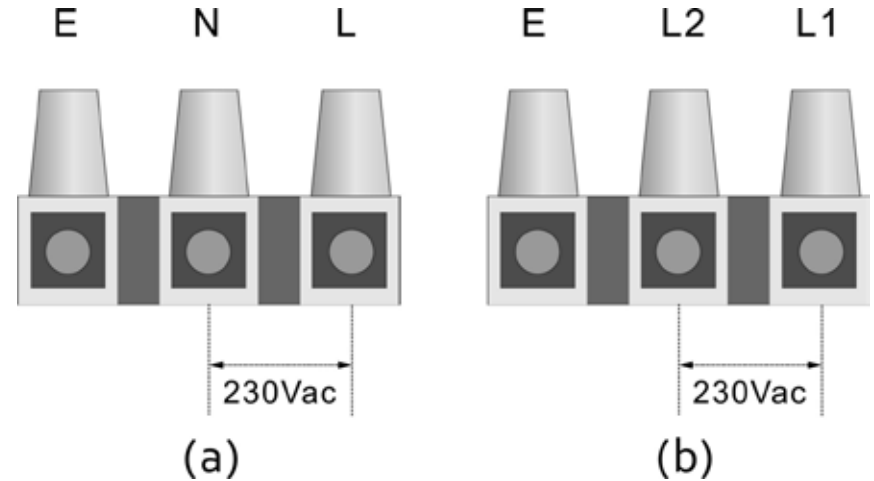

Fig. 3

Step 5. Fix the housing cover of the SR Series Inverter and evenly tighten the four screws.

To prevent risk of electric shock, ensure the Earth wire is properly Earthed before operating the SR Series Inverter.

Suggested cable width for AC wire;

Model	Diameter (mm)	Area (mm ²)	AWG no.
SR 4200TL/5000TL	>2.59	>5.5	>10
SR 1500TL/ 2000TL/ 3000TL	>2.05	>3.5	>12

Connecting the PV Array (DC)

PV Module Requirements

The SR Series Inverters are designed with input connector terminals for the connection of solar modules. Models SR1500TL/2000TL/3000TL have one connector terminal, Models SR4200TL/5000TL have two connector terminals. Each connector terminal can be connected to a string of PV modules. A string refers to a number of PV modules/panels connected in sequence. Each string can feature any number of solar modules, provided the guidelines listed below are adhered to (refer Fig. 4). Where inverters have input connector terminals for two strings (eg SR4200TL/5000TL), each string configuration does not have to be identical.

Wiring to the PV Module

The SR Series Inverter is equipped with PV quick connects for connecting up to two PV strings.

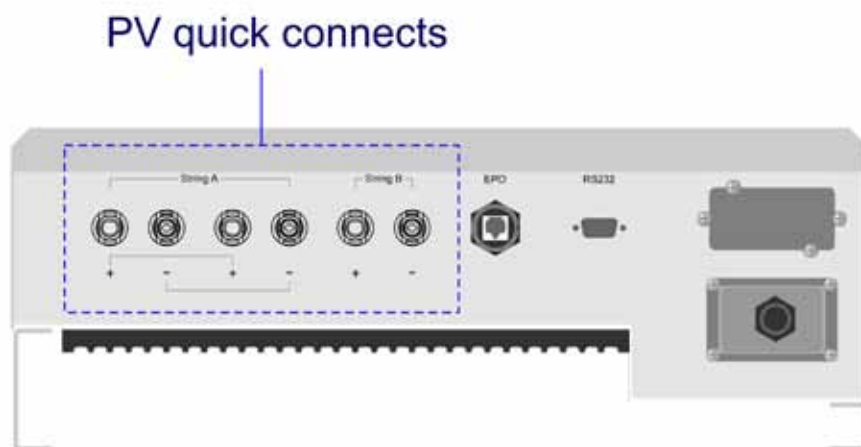

Fig. 4

GUIDELINES: When determining the number of panels required in a PV string, ensure the following three requirements are met:

1. To avoid damage to the SR Series Inverter, make sure the maximum open circuit voltage (Voc) of each PV string is less than 500 Vdc under any condition. Voltage over 500 Vdc will damage the inverter.
2. Do not exceed the maximum array short circuit/current rating marked on the SR Series Inverter.
3. To achieve maximum energy harvest from your array, ensure that the Vmp (voltage at maximum power) does not drop below 150 Vdc or increase above 450 Vdc under most conditions.

To wire the PV array to the SR Series Inverter, follow these steps:

- Step 1:** Check that the PV generator connectors have the right polarity and do not exceed the maximum string voltage.
- Step 2:** Connect the POSITIVE (+) wire from the #1 PV string to SR Series Inverter positive (+) connect.
- Step 3:** Connect the NEGATIVE (-) wire from the #1 PV string to SR Series Inverter negative (-) connect.
- Step 4:** Connect the Earth wire from the #1 PV string to SR Series Inverter Earth connect.
- Step 5:** If necessary, repeat Step 2 and Step 4 for the #2 PV string. Double check that the wires are in the proper locations.



Fig. 5
DC Connections for a
Two-String PV Array

Front Panel Functional Descriptions

Symbols on the LCD Display Panel



LCD Display	
Symbol	Description
LINE	Utility Source
	Inverter working in specified mode
	Solar Cell
	Inverter operation mode Flow Chart
	4 Digits Measurement Display

LED Indicators		
2		RED LED steadily lights up to indicate an Earth fault or a DC input isolation fault.
3		YELLOW LED steadily lights up to indicate that the utility (ex. voltage, frequency etc.) does not match the input standard of the inverter.
4		Green LED steadily lights up to indicate that the Solar Cell power is greater than sleep power; the LED flashes to indicate that the Solar Cell power is smaller than sleep power.
Control Keypads		
5		Special Function Log in /out.
6		Go to next page.
7		To re-confirm the change of Inverter Setting.
8		Go to previous page.

Starting the SR Series Inverter

Before the inverter is started, check the following:

The housing cover is securely screwed tight.

The AC breaker is OFF.

The DC cables (PV strings) are fully connected.

The AC (utility) cable is connected correctly.

Operation Test and Installation Instruction

Connect the PV string voltage by switching on the DC circuit breaker. The SR Series Inverter starts automatically when it receives DC voltage greater than 120Vdc. All of the LEDs will light up. The LCD display will illustrate drawing A.

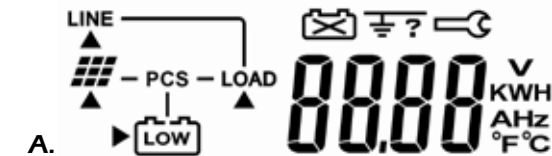

After 3 seconds, the LCD display will illustrate from drawing A to drawing B1 and B2. The Green LED flashes to indicate that the DC input power is smaller than sleep power. The yellow LED steadily lights up to indicate that no utility exists.



Turn on the AC breaker. If Utility specification (ex. voltage, frequency etc.) is matched with the specs of the inverter, after 300 seconds the LCD display will illustrate drawing C. And the Yellow LED will go out to indicate that the utility is acceptable by the inverter. If the Utility's specification (ex. voltage, frequency etc.) is not matched with the specs of the inverter then an error code or error status will be shown on the screen.



After 5 seconds, if the DC soft start of the inverter is successful, the LCD display will illustrate drawing D. The Green LED still flashes.



After 10 seconds, if the AC soft start of inverter is successful the LCD display will illustrate drawing E.

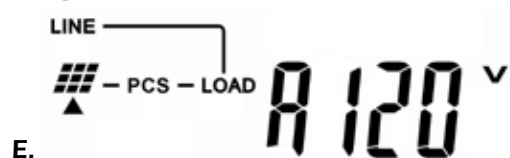

If the inverter is in failure (ex. Output Current Over Range), then an error code or error status will be shown on the screen. (Example: Drawing F)



If start-up operation of the inverter is complete and successful. The LCD display will illustrate drawing E.

Checking Measured Values & Figures

If you would like to check the measured values and figures detected by the Inverter, please scroll up and scroll down using the key pad.

When scrolling down using the key pad, the LCD display will illustrate as follows:

Input DC Voltage of String A, as drawing G.



Input DC Voltage of String B, as drawing H.



Input DC Current of String A, as drawing I.



Input DC Current of String B, as drawing J.



Output Power of Booster A, as drawing K.



Output Power of Booster B, as drawing L.

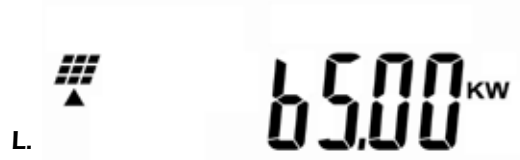

Output Voltage of Inverter (Utility Voltage), as drawing M.

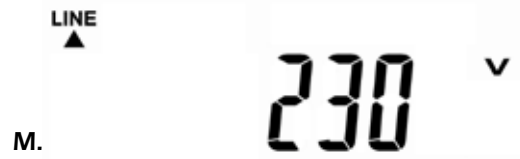

Output Frequency of Inverter (Utility Frequency), as drawing N.



Output Current Supplied to Load, as drawing O.



Output Power Supplied to Load, as drawing P.



Energy KWH Supplied to Load, as drawing Q.



Inverter Inner Temperature (°C, °F) , as drawing R.





Heat Sink Temperature (°C, °F) , as drawing S.

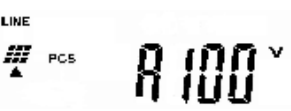

SR Series Inverter Status Descriptions

The SR Series Inverter starts up automatically when DC-power from the PV panel is sufficient. Once the inverter starts, it enters into one of the following status:

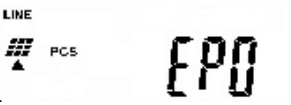
Operation mode	LCD panel display	Description
Normal		In this mode, the SR Series Inverter works normally. Whenever the supplied power from PV panel is sufficient ($500\text{VDC} > \text{PV} > 120\text{VDC}$), the SR Series Inverter converts power to the grid as generated by the PV panel. In normal mode, the green LED is on to indicate that power is being fed to the grid.
Standby		If the power is insufficient, ($60\text{VDC} < \text{PV} < 120\text{VDC}$) the SR Series Inverter enters into a standby mode but will attempt to connect to the grid.
Error		The internal intelligent controller can continuously monitor and adjust the system status. If the SR Series Inverter finds any unexpected conditions such as grid problems or internal failure, it will display the information on its LCD and light up the red LED.
EPO		Emergency Power Off Mode. In this mode, the SR Series Inverter does not take any power from the grid.
Shutdown		In case of little or no sunlight, the SR Series Inverter automatically stops running. In this mode, the SR Series Inverter does not take any power from the grid. The display and all of the LEDs on the front panel do not work.

The Communications Interface

Standard communications interface

RS232 interface definition

The RS232 interface shall be set as follows:

Baud Rate	9600 bps
Data Length	8 bits
Stop Bit	1 bit
Parity	None

The Pin Assignments of true RS232 type. The pin assignments of true RS232 type are illustrated as follows:

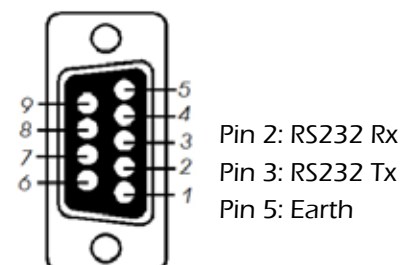

Optional Communication Card

Hardware Installation Procedure

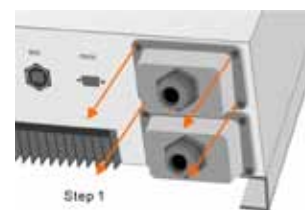

Open the top and sides of the cabinet

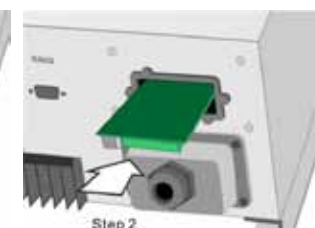

Put the communication card into the slot

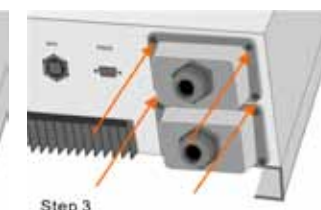

Screw back the side and top cover and complete the installation

RS-485 card



CN1 is for the function of the terminal resistor. Short Pin 1-2 to enable the function and short Pin 2-3 to disable it.

CN2 is RS485 terminal definition

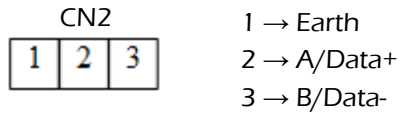

USB card

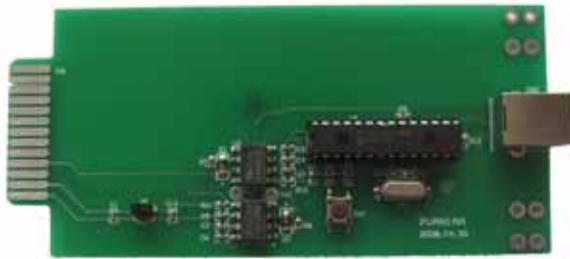

CN2 for USB.

Definition
Comply with USB version 1.0 & 1.5Mbps.
Comply with USB HID Version 1.0.
The Pin Assignments of the USB card:

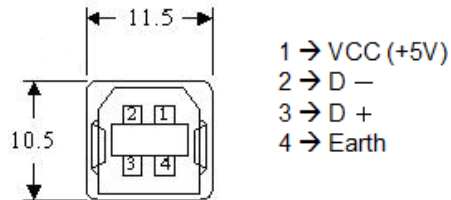

True Relay Contact Board (DCE-B card)



The pin assignments of 10-Pin Terminal:

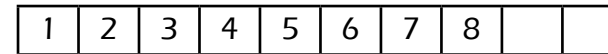

- Pin 1:** Voltage of utility is abnormal.
- Pin 2:** PV strings voltage is normal.
- Pin 3:** PV strings voltage is abnormal.
- Pin 4:** Frequency of utility is abnormal.
- Pin 5:** Anti-islanding.
- Pin 6:** Output current of inverter exceeds range.
- Pin 7:** Temperature of heat-sink is too high.
- Pin 8:** Common.

The capacity of each relay contact is 40Vdc/25mA.
Flexible signal output for N.C. (Normal close) or N.O. (Normal open) contact by shorting Pin 1-2 or Pin 2-3 from of JP1-5.

TCP/ IP (Ethernet) cards
For installation, please refer to the User's Manual attached with the card.



Inverter Status Diagnostics and Repair

The SR Series Inverter is equipped with an on-board self diagnostic system. This system can automatically identify a large number of possible operational issues and provide notification via its LCD screen. This system makes it possible to quickly isolate technical issues, and to distinguish between Service Codes related to the installation versus Service Codes which are internal to the inverter. Whenever the self diagnostic system has identified a particular issue, the respective Service Code is displayed on the LCD screen.

Table 2. Inverter Error Code and Error Code Description

LCD Indicate	Designation	Description	Repair
Er00	DC_BUS pre-Charge fail	The Inverter is in soft start procedure, but the DC Bus cannot reach and maintain anticipative charging voltage.	<ol style="list-style-type: none"> 1. Disconnect ALL PV (+) or PV (-). 2. Wait for few seconds. 3. After the LCD switches off, reconnect and check again. 4. If error code keeps recurring, contact your local distributor.
Er03	INVERTER voltage abnormal	The Inverter Output voltage is abnormal.	
Er07	DC_BUS over-voltage	The DC BUS inside is lower or high than expected.	
Er08	DC_BUS under-voltage		
Er17	EEPROM ERROR on the control board	EEPROM Data is wrong.	
Er19	DC_BUS discharge fail	Capacitors of the DC Bus can't be discharged down.	
Er22	Output Relay fail	The Inverter Output Relay is abnormal.	
Er24	Output Current sense fail	The Inverter Output Current fails to detect.	
Er25	BOOSTER_A over-current	Over-current on the DC side. This fault code is displayed if the current in the DC network is larger than specified.	
Er26	BOOSTER_B over-current		
Er30	Rating setting of Driver board does not match EEROM of control board	EEPROM Data is wrong.	

LCD indicate	Designation	Description	Repair
Er06	EPO	Inverter enters into EPO mode (Emerge Power Off).	<ol style="list-style-type: none"> 1. Remove the short circuit occurred at the EPO terminal. 2. If error code keeps recurring, contact your local distributor.
Er09	Inverter Output over-current	Over-current on the AC side. This fault code is displayed if the current in the AC network is larger than specified.	<ol style="list-style-type: none"> 1. Turn off AC breaker, and then check the peripheral AC system configuration and the grid conditions. 2. If error code keeps recurring, contact your local distributor for help.
Er11	Inverter over-load	Overload on the AC side. This fault code is displayed if the load in the AC network is larger than specified.	Contact your local distributor for help.
Er13	Inverter short-circuit	Short-circuit on the AC side.	Contact your local distributor for help.
Er14	Inverter PLL fail	The phase of Inverter can't synchronize with the utility.	Contact your local distributor for help.
Er29	Inverter output DC current over spec.	The DC component of the electricity fed into the grid is longer than the permissible range.	Contact your local distributor for help.
Er10	Inverter Over temperature	The internal temperature is too high.	<ol style="list-style-type: none"> 1. Try to reduce the ambient temperature. 2. Move the inverter to a cooler place. 3. If error code keeps recurring, contact your local distributor for help.
Er18	Heat Sink Over temperature	The Heat Sink temperature is too high.	Contact your local distributor for help.

Table 3. Grid Fault Alarm Code and Alarm Code Description

LCD indicate	Designation	Description	Repair
AL00	Utility Voltage Over-Voltage	Utility Voltage greater or smaller than the permissible value.	1. Wait for 1 minute, if the grid returns to normal, the inverter will automatically restart.
AL01	Utility Voltage Under-Voltage		2. Check grid connection, such as wires and connectors.
AL02	Utility Voltage Over-Frequency	Utility Frequency greater or smaller than the permissible value.	3. Make sure grid voltage and frequency meet the proper specifications. 4. If error code keeps recurring, contact your local distributor for help.
AL03	Utility Voltage Under-Frequency		Contact your local distributor for help.
AL04	BOOSTER_A Input Over-Voltage	Over or Under voltage at DC input.	1. Disconnect ALL PV (+) or PV (-).
AL05	BOOSTER_A Input Under-Voltage		2. Check the open PV voltage is outside the 120Vdc ~ 500Vdc.
AL06	BOOSTER_B Input Over-Voltage		3. If PV voltage is normal and the problem still occurs, contact your local distributor for help.
AL07	BOOSTER_B Input Under-Voltage		Contact your local distributor for help.
AL08	Anti-Islanding	No Utility or Utility Fail.	1. Disconnect ALL PV (+) or PV (-)
AL 13	Phase of Utility is fail		2. Check grid connection, such as wires and connectors. 3. Check grid usability.
AL14	Waveform of Utility is fail		4. If Utility is normal and the error code keeps recurring, contact your local distributor for help.

LCD indicate	Designation	Description	Repair
AL09	Inverter Voltage unbalance	Inverter Voltage Waveform is in unbalance.	1. Shut down inverter (unplug PV generator from the input). 2. Check grid usability and restart inverter (plug PV generator from the input). 3. If error code keeps recurring, contact your local distributor for help.
AL10	GFDI	Leakage current on Earth conductor is too high.	1. Unplug PV generator from the input, check AC peripheral system. 2. After the problem is cleared, re-plug the PV. Check the PV-Inverter status. 3. If error code keeps recurring, contact your local distributor for help.
AL11	Isolation Fault	The impedance is between PV (+) and PV (-) and Earth is smaller than 1MΩ.	1. Disconnect ALL PV (+) or PV (-). 2. Check the impedance between PV (+) & PV (-) and Earth. The impedance must be larger than 2MΩ. 3. If error code keeps recurring, contact your local distributor for help.

Specifications

Unit Model		SR1500TL	SR2000TL	SR3000TL	SR4200TL	SR5000TL
Inverter Technology	Conversion Mode	Sine-wave, Current source, High frequency PWM				
	Isolation Method	Transformer-less Design*				
DC Input Data						
Nominal DC Voltage		360 VDC				
Maximum DC Input Voltage		500 VDC				
Work Range		120VDC~500VDC**				
Maximum DC Input Current (each MPPT follower)		10.5 Amp	14.6 Amp	22 Amp	14.7 Amp	18.3 Amp
MPPT Range		150 VDC ~ 450 VDC				
MPPT Follower		1			2	
AC Output Data						
Nominal AC Power		1500	2000	3000	4000	5000
Nominal AC Voltage		AC 230V				
Output Connection Method		1-Phase / 2-Wires (L, N, E)				
AC Voltage Range		207~264 Vac				
Nominal AC Current		6.5 Amp	8.7 Amp	13 Amp	17.4 Amp	21.7 Amp
Frequency		47 ~ 50.5 Hz				
Power Factor		>0.99 with nominal AC current				
DC Injection		< 20mA				
Current Distortion		Total Harmonic current : Less than 5% Single Harmonic current : Less than 3%				
Efficiency Data						
Maximum Cont. Efficiency		>96%				
Euro Efficiency		>94%				
Environment						
Operating Temperature		-20 °C ~ +50 °C				
Humidity		0 to 90% (without condensation)				
Altitude		0 ~ 2000 M / 0 ~ 6600 ft				
Mechanical Data						
Dimensions (H x W x D in mm)		455 x 430 x 170			455 x 510 x 170	
Weight (Kgs)		23			28	
Protection Class		IP65, Outdoors				
Cooling		Free Convection				
AC Connection		Terminal				
DC Connection		Multi-Contact				

Unit Model		SR1500TL	SR2000TL	SR3000TL	SR4200TL	SR5000TL
Communication						
Communication Interface	Standard	RS232				
	Optional	USB, RS485, dry contact, TCP/IP				
Front Panel						
LCD	Boost input Voltage/Boost input Current/Boost input Power/AC output Voltage /AC output frequency/AC output current /AC output power/AC Energy yield/Inner Temperature/Heat sink Temperature /Status message/ Error message					
LED	RED	Leakage current fault or DC input isolation fault				
	Yellow	Spec. of Utility is not matched with the Utility specifications of the inverter				
	Green	Solar Cell power is greater or smaller than sleep power				
Key Pad	UP key/ Down key/ Function key/ Enter key					
Protection						
Utility	Over/under Voltage, Over/ under Frequency, Earth fault, DC Isolation fault					
Islanding operation detection	Passive : Voltage phase jump detection Active : Reactive power control					
Over Temperature	Reduced output power					
Certification						
Performance and Safety Compliance	ER G83/1, VDE0126-1-1, EN50178, IEC62103					
EMI/EMC	EN 61000-6-1, EN 61000-6-2, EN 61000-6-3, EN 61000-6-4					
North American	UL1741, IEEE1547					
Australia	AS3100, AS/NZS4777					

* If isolation is necessary, option one extra transformer.

** The rated range should be 150VDC-500VDC in order to get the rated output.



www.sunnyrooproducts.com