



# AURORA<sup>®</sup>

## Photovoltaic Inverters

---

# INSTALLATION AND OPERATOR'S MANUAL

---

*Model number: PVI-2000-AU*

*Rev. 1.0*

---

### REVISION TABLE

Document Revision	Author	Date	Change description
1.0	Gianluca Pieralli	30/09/2008	First release of the document



**SAVE THESE INSTRUCTIONS!**



**IMPORTANT SAFETY INSTRUCTIONS**

**POWER-ONE:** Reproduction and disclosure, even partially, of the contents of this manual are strictly forbidden without prior authorization of Power-One.

---

## IMPORTANT SAFETY INSTRUCTIONS

This manual contains important safety and operational instructions that must be accurately understood and followed during the installation and maintenance of the equipment.

To reduce the risk of electrical shock hazards, and to make sure the equipment is safely installed and commissioned, special safety symbols are used in this manual to highlight potential safety risks and important safety information. The symbols are:



**WARNING:** the paragraphs highlighted by this symbol contain processes and instructions that must be absolutely understood and followed to avoid potential danger to people.







**NOTE:** the paragraphs highlighted by this symbol contain processes and instructions that must be rigorously understood and followed to avoid potential damage to the equipment and negative results.

The equipment is provided with several labels, some of them with a yellow background, which are related to safety issues.

Make sure to read the labels and fully understand them before installing the equipment.

The labels use the following symbols:

	Equipment grounding conductor (Main grounding protective earth, PE)
	Alternate Current (Ac) value
	Direct Current (Dc) value
	Phase
	Grounding (Earth)

## USEFUL INFORMATION ON SAFETY STANDARDS

### FOREWORD

- The installation of AURORA must be performed in full compliance with national and local standards and regulations.
- AURORA has no internal user serviceable parts other than fuses.  
For any maintenance or repair please contact the nearest authorized repair centre. Please contact your reseller if you need to know the nearest authorised repair centre.
- Read and understand all the instructions contained in this manual and become familiar with the safety symbols in the relevant paragraphs before you install and commission the equipment.
- The connection to the distribution grid must be done only after receiving approval from the distribution utility as required by national and state interconnection regulations, and can be done only by qualified personnel.
- Cover the photovoltaic panels with dark opaque sheets before they are connected to avoid any chance of high voltages appearing at the connecting wire terminations.

## **GENERAL**

During inverter operation, some internal parts can be energised, in some cases, internal parts can move or rotate and some surfaces can be hot.

Unauthorised removal of the necessary protections, improper use, incorrect installation or incorrect operation may lead to serious damage to people and objects.

All transport, installation and start-up, as well as maintenance operations, shall be carried out by skilled and trained personnel (all national regulations on accidents prevention and electrical safety shall be complied with!!!).

Only qualified and trained people have skills for the assembling, start-up and operation of the product, as well as the necessary requirements and qualifications to perform such operations.

## **INSTALLATION**

All equipment shall be installed according to the instructions and specifications mentioned in the corresponding documents.

In particular, during transport and handling, parts shall not be bent and/or the insulation distances shall not be changed. There should be no contact between electronic parts and connection terminals.

Electrical parts must not be mechanically damaged or destroyed (potential health risk).

## **ELECTRICAL CONNECTION**

The Aurora inverter should be installed in compliance with all prevailing local and national regulations

Electrical connections shall be carried out in accordance with the applicable regulations, such as conductor sizing, over-current protection devices and grounding connection.

## **OPERATION**

Systems with inverters shall be installed in accordance with applicable electrical safety and personnel safety requirements. After the inverter has been disconnected from the both input power and output power connections allow the internal capacitors to discharge before working on the equipment

Comply with all corresponding marks and symbols present on each device. During operation, make sure that all covers and doors are closed.

## **MAINTENANCE AND SERVICE**

Comply with manufacturer's recommendations.

**SAVE ALL DOCUMENTS IN A SAFE PLACE!**

## **PVI-2000-AU**

This document applies to the above-mentioned inverters, only



The identification plate present on the inverter includes the following data:

- 1) Manufacturer Part Number
- 2) Model Number
- 3) Serial Number
- 4) Production Week/Year

---

**CONTENTS:**

<b>1</b>	<b>FOREWARD .....</b>	<b>11</b>
1.1	PHOTOVOLTAIC ENERGY .....	11
<b>2</b>	<b>SYSTEM DESCRIPTION.....</b>	<b>12</b>
2.1	MAIN ELEMENTS OF A PV SYSTEM: “STRINGS AND ARRAYS” .....	13
2.2	DATA TRANSMISSION AND CHECK .....	15
2.3	AURORA TECHNICAL DESCRIPTION .....	15
2.4	PROTECTIVE DEVICES .....	17
2.4.1	<i>Anti-Islanding</i> .....	17
2.4.2	<i>Panel Ground Fault</i> .....	17
2.4.3	<i>Further Protective Devices</i> .....	18
<b>3</b>	<b>INSTALLATION .....</b>	<b>19</b>
3.1	PACKAGE INSPECTION .....	19
3.2	PACKAGE CHECK LIST.....	20
3.3	CHOOSING INSTALLATION LOCATION .....	21
3.4	WALL MOUNTING .....	22
3.5	PRELIMINARIES TO ELECTRICAL CONNECTIONS .....	24
3.6	ELECTRICAL CONNECTIONS .....	28
<b>4</b>	<b>START-UP .....</b>	<b>30</b>
<b>5</b>	<b>MONITORING AND DATA TRANSMISSION.....</b>	<b>31</b>
5.1	USER INTERFACE MODE .....	31
5.2	AVAILABLE DATA .....	33
5.2.1	<i>Real time data</i> .....	33
5.2.2	<i>Internally Logged Data</i> .....	34
5.3	LED INDICATORS .....	35
5.4	MESSAGES AND ERROR CODES.....	40
5.5	LCD DISPLAY .....	43
5.5.1	<i>Statistics menu</i> .....	46



---

5.5.1.1	Total.....	47
5.5.1.2	PARTIAL .....	48
5.5.1.3	TODAY .....	49
5.5.1.4	LAST 7 DAYS .....	50
5.5.1.5	LAST MONTH.....	51
5.5.1.6	LAST 30 DAYS .....	52
5.5.1.7	LAST 365 DAYS .....	53
5.5.1.8	USER PERIOD.....	54
5.5.2	<i>Settings menu</i> .....	55
5.5.2.1	ADDRESS .....	56
5.5.2.2	DISPLAY SETTING.....	56
5.5.2.2.1	<i>LIGHT</i> .....	58
5.5.2.2.2	<i>CONTRAST</i> .....	59
5.5.2.2.3	<i>BUZZER</i> .....	59
5.5.2.2.4	<i>GRAPH SET</i> .....	60
5.5.2.3	SERVICES .....	61
5.5.2.4	CHANGE PW .....	61
5.5.2.5	CURRENCY.....	62
5.5.2.6	CLOCK.....	63
5.5.2.7	LANGUAGE .....	64
5.5.3	<i>Information menu</i> .....	65
<b>6</b>	<b>DATA CHECK AND COMMUNICATION.....</b>	<b>67</b>
6.1	RS-232 AND RS-485 SERIAL LINK .....	68
6.2	ADDRESS SELECTION .....	72
6.3	MEASUREMENT ACCURACY.....	73
<b>7</b>	<b>TROUBLESHOOTING .....</b>	<b>75</b>
<b>8</b>	<b>TECHNICAL FEATURES.....</b>	<b>77</b>
8.1	INPUT VALUES .....	77
8.2	OUTPUT VALUES .....	80
8.3	GRID PROTECTION CHARACTERISTICS .....	81
8.4	GENERAL CHARACTERISTICS .....	81

---

8.5 POWER DERATING ..... 82

## **1 FOREWARD**

This document contains a technical description of the AURORA photovoltaic inverter so as to provide the installer and user all the necessary information about installation, operation and use of AURORA.

### **1.1 PHOTOVOLTAIC ENERGY**

Industrialised countries (greater energy consumers) have been experimenting with energy-saving methods and reducing pollutant levels. This may be possible through a shrewd and rational consumption of well-known resources, and also by looking for new forms of clean and inexhaustible energy.

Renewable sources of energy are fundamental to solving this problem. Under these circumstances, solar energy exploitation to generate electrical (photovoltaic) energy is becoming more and more important worldwide.

Photovoltaic energy is, in any case, of great advantage to the environment because the radiated energy we receive from the sun is transformed directly into electrical energy without any combustion process and without producing any pollution.

## 2 SYSTEM DESCRIPTION

AURORA is an inverter that exports energy to the electrical power distribution grid. Photovoltaic panels transform the solar radiation into electrical energy in the form of direct (Dc) current (through a photovoltaic field, also known as PV generator); In order to utilise this energy and feed it back to the distribution grid, this energy shall be turned into alternating (Ac) current. AURORA does this conversion, also known as Dc to Ac inversion, in a very efficient way, without using rotating parts but only static power electronic devices.

When used in parallel with the grid, the alternate current generated by the inverter is directly fed to the domestic distribution circuit, which in turn is also connected to the public power distribution grid.

The solar energy system can thus feed power to all the connected devices, such as lighting devices, household appliances, etc.

If the energy generated by the photovoltaic system is not enough, the energy necessary to ensure the standard operation of the connected devices is drawn from the public power distribution grid. If the energy produced exceeds that used, the difference is directly fed to the grid, thus becoming available to other users.

According to national and local standards and regulations the produced energy can be sold to the grid or credited to the user for future consumption.

## 2.1 Main Elements of a PV System: “STRINGS and ARRAYS”

The so-called “string” technology has been developed in order to reduce the installation costs of a photovoltaic system as much as possible. These costs are mainly related to the wiring operations on the Dc side of the inverter and the consequent distribution on the Ac side.

A photovoltaic PANEL is composed of many photovoltaic cells assembled on the same mount. A STRING is composed of a certain number of panels electrically connected in series. An ARRAY is composed of one or more strings connected in parallel.

Larger photovoltaic systems can be composed of a certain number of arrays, connected to one or more AURORA inverters. By maximizing the number of panels in series per string, the cost and complexity of the system wiring can be reduced.

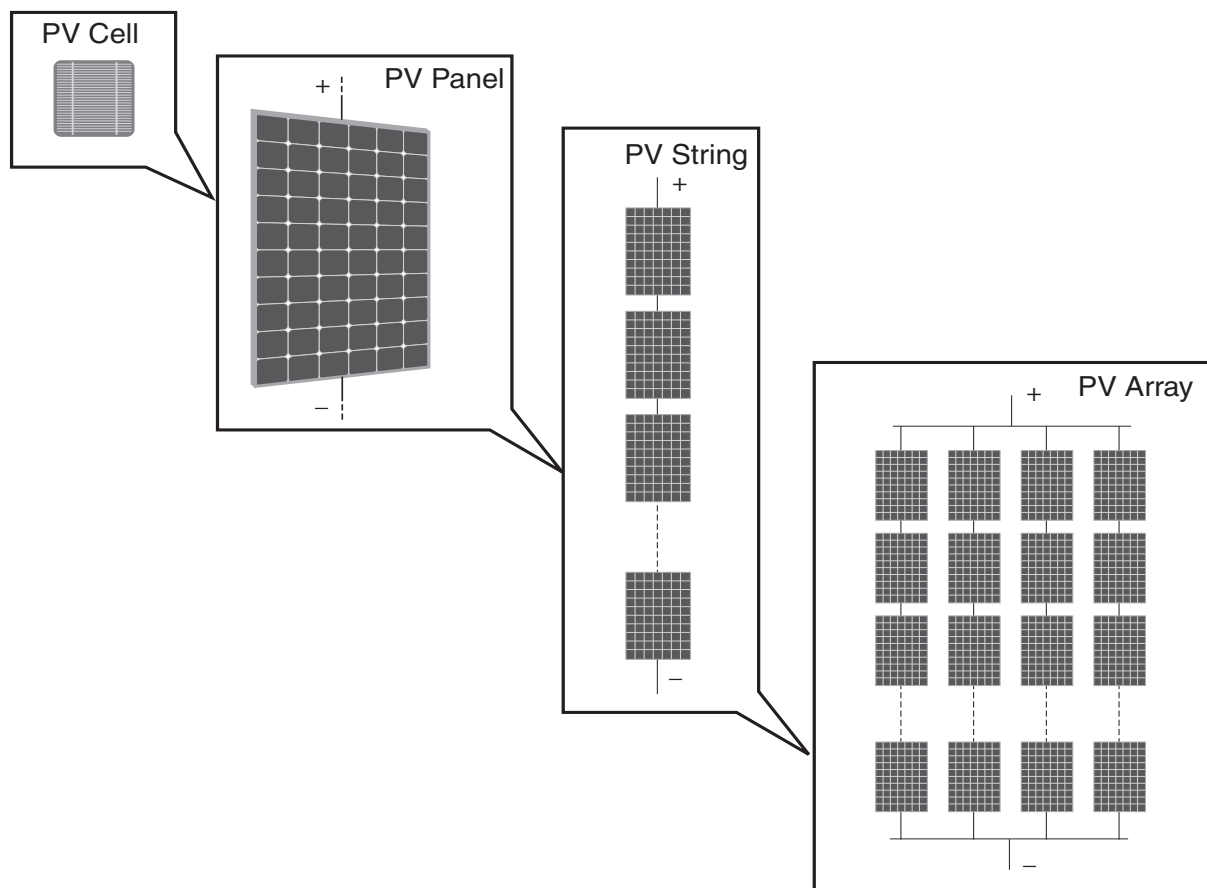

Fig.2 Array Composition

Array voltage value shall be within an acceptable range for the inverter. Please refer to the technical data for the AURORA for details on the Dc operating voltage range.



**WARNING:** String voltage shall not exceed 600 Vdc for any reason, to prevent any damage to the equipment

**NOTE:** The minimum required input voltage for start the initial grid connection sequence is 200Vdc.

When Aurora is connected, it will export energy on the grid since the input range will remain between 90Vdc and 580Vdc.

The total current of an array must also be within the capability limits of the inverter. The 2000W model of AURORA is capable of handling a single array and the maximum input current can be 10Adc.

In case the photovoltaic system exceeds the capabilities of a single AURORA inverter, additional inverters can be added to the system, each connected to a suitable section of the photovoltaic field on the Dc side, and to the grid on the Ac side.

Each AURORA inverter will work independently from the others and will push to the grid the maximum power available from its own section of the photovoltaic panels.

The actual decisions on the way the photovoltaic system is structured and wired depend on a number of factors and considerations, such as type and model of panels, available area, location, energy targets, as well as on good design practices.

Power-One provides a system configuration tool on its website ([www.power-one.com](http://www.power-one.com)) that can assist in modelling the system.

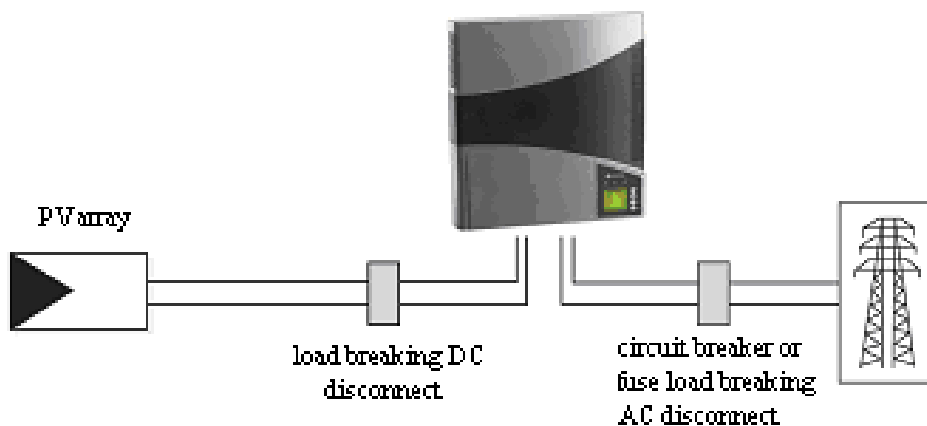

Fig.3 Simplified diagram of a photovoltaic system

## 2.2 Data transmission and check

In case multiple inverters are used, they can be monitored remotely by using an advanced communication system based on the RS485 serial interface or on the Power Line Modem (PLM) technology. For further information, refer to the corresponding sections of this manual.

## 2.3 AURORA Technical Description

Figure 4 shows the AURORA block diagram. The main blocks are given by the input Dc-Dc converters (also known as “booster”) and the output inverter. Both the Dc-Dc converters and the output inverter work at high switching frequency to minimize size and weight.

This model of AURORA is transformer-less, that means that there is no galvanic isolation between input and output. This allows an increase in the inverter efficiency. AURORA, on the other hand, is equipped with all the protection needed to operate safely and to comply with existing safety regulations even without an isolation transformer, as described in the paragraph regarding protective devices.

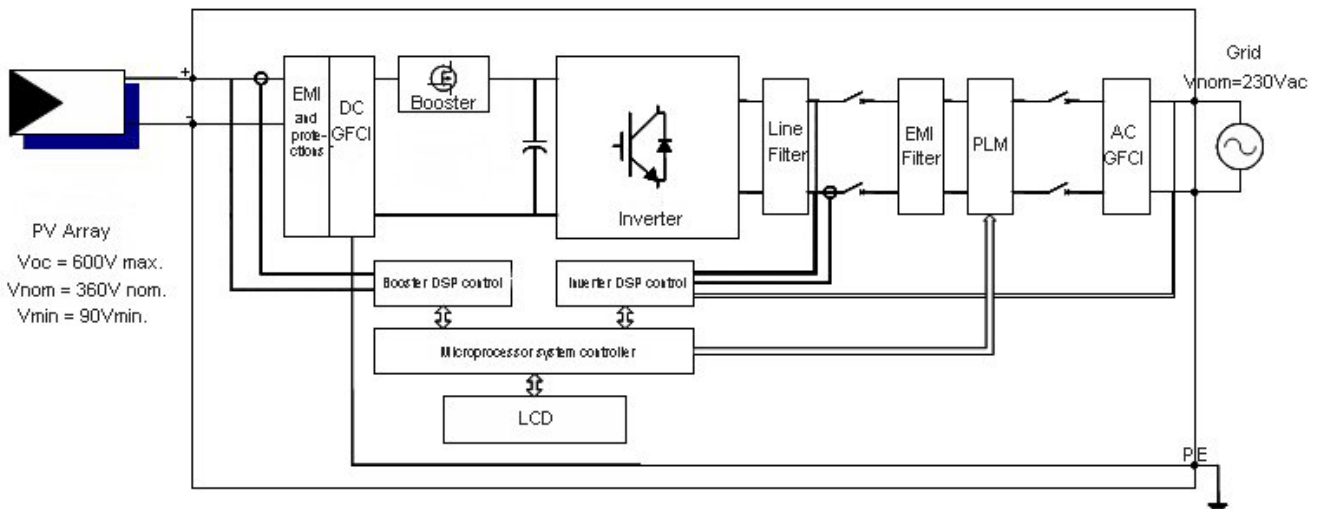

Fig.4 AURORA block diagram

The block diagram shows the model AURORA PVI-2000.

Thanks to its high efficiency and its widely dimensioned thermal dissipation system, this inverter guarantees maximum power operation over a wide ambient temperature range.

The inverter is controlled by two independent Digital Signal Processors (DSP) and a central microprocessor.

The connection to the electrical grid is, therefore, controlled by two independent computers, in compliance with electrical standards, power system standards and safety standards.

the AURORA operative system communicates with the relative components to carry out data analysis.

All this guarantees an optimal operation of the whole system and a very high performance in every insulation and load situation, always in compliance with the relative standards and regulations.



## **2.4 Protective devices**

### **2.4.1 Anti-Islanding**

The Aurora inverter will automatically disconnect from the utility grid when the utility grid is out of range or when the inverter shuts down due to a fault condition, in order to guarantee protection for persons operating on the utility grid, in compliance with the national standards.

AURORA PVI-2000 is equipped with an advanced Anti-Islanding protection certified according to the following standards:

- AS4777.3-2005

### **2.4.2 Panel Ground Fault**

This version of Aurora is designed for connection to floating Photovoltaic arrays only, with the positive and negative terminals from the panels are not connected to the Ground (the metallic support of the panel instead shall be connected to safety Ground in accordance with existing electrical safety regulations). An advanced ground fault protection circuit continuously monitors the ground connection and shuts down AURORA in case a ground fault is detected and indicates the ground fault condition by means of a red LED on the front panel. A terminal for the equipment grounding conductor is provided in the AURORA inverter. For further information, please see section 3.5.3.

### **2.4.3 Further Protective Devices**

AURORA is equipped with additional protections to guarantee safe operation under all circumstances. The protections include:

- Continuous monitoring of the grid voltage to ensure the frequency and voltage values are within the proper operational limits;
- Control of the internal temperatures to automatically limit power when needed to make sure the unit does not overheat (heat-sink temperature  $\leq 70^{\circ}\text{C}$  [ $158^{\circ}\text{F}$ ]).

**The many AURORA control devices determine a redundant structure to guarantee safe operating use.**

---

### 3 INSTALLATION



**WARNING:** The electrical installation of AURORA must be made in accordance with the local and national electrical standards and regulations.



**WARNING:** The connection of AURORA to the electrical distribution grid must be performed only after receiving authorization from the utility that operates the grid.

#### 3.1 Package inspection



**NOTE:** The distributor presented your AURORA to the delivering carrier securely packed and in perfect conditions. Upon acceptance of the package from the distributor, the delivering carrier assumes responsibility for its safe arrival to you. Despite of the attention paid by carrier in handling it, sometimes the package and its contents might be damaged.

Please, carry out the following checks:

- Examine the shipping box for any visible damage: punctures, dents or any other signs of possible internal damage;
- Describe any damage or shortage on the receiving documents and have the carrier sign their full name;
- Open the shipping box and inspect the contents for internal damage. While unpacking, be careful not to discard any equipment, parts or manuals. If any damage is detected, call the delivering carrier to determine the appropriate action. They may require an inspection. Save all shipping material for the inspector to see!

If the inspection reveals damage to the inverter call your retailer, or authorized distributor. They will determine if the equipment should be returned for repair. They will also provide instructions on how to get the equipment repaired;

- It is your responsibility to file a claim with the delivery carrier. Failure to properly file a claim for shipping damages may void warranty service for any physical damages later reported for repair;
- Save AURORA original packaging, as it will have to be used in case the equipment has to be shipped out for repairs.

### 3.2 Package Check List

Description	Quantity (No.)
AURORA Photovoltaic Inverter	1
Mounting bar	1
Bag containing a wall fixing kit composed of 3 stainless steel screws, 3 blocks and a TX10 tap wrench, and a connector kit, composed of 1 signal wire gland, a double-hole seal, 1 positive Multicontact connector cap and 1 negative connector cap, 1 Binder connector counterpart.	1
Copy of this manual	1
Certificate of warranty	1
CD-Rom with communication software	1

### 3.3 Choosing installation location

The location for the installation of AURORA should be selected in accordance to the following recommendations:

- This model of AURORA is designed for indoor environments; the IP21 protection prevents damages to the unit in case of vertical water dropping.
- AURORA should be placed at a suitable height from the ground to allow easy reading of the front display.
- Leave enough room around the unit to allow easy installation and maintenance (Fig 5).
- Choose a location sheltered from sun radiation and able to provide some ventilation.
- The screw and tabs for wall mounting need to be chosen according to the wall construction material (stone, full bricks, holed bricks, etc).



**WARNING:** The metal surface in the back of AURORA could reach high operating temperatures (**up to 70°C**). Avoid contact of the surface with materials that are flammable or sensitive to high temperature (wallpaper, fabrics, wood, etc.)

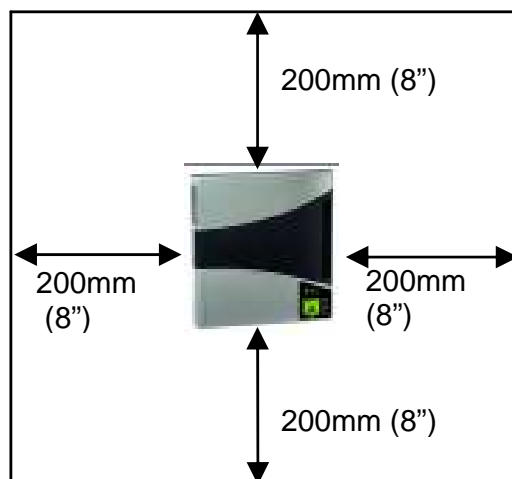

Fig.5 Installation location

### 3.4 Wall Mounting

A set of standard expansion stainless steel screws and an aluminium bracket, onto which the inverter will be fixed, are provided to mount AURORA to a masonry wall. In case of different materials make sure to select the proper mounting hardware. Always use stainless steel mounting hardware, if the supplied hardware is not used. Three holes are needed to mount AURORA to the wall: two on the top for the bracket, and one on the bottom to secure the inverter to the wall

- 1) Open the panel located in the lower part of AURORA, using the TX10 tap wrench provided to loosen the screw which locks the panel, making it slide downwards (Fig. 6). Once you have removed the panel, at the centre of the uncovered area, you will see a hole for the fixing screw.

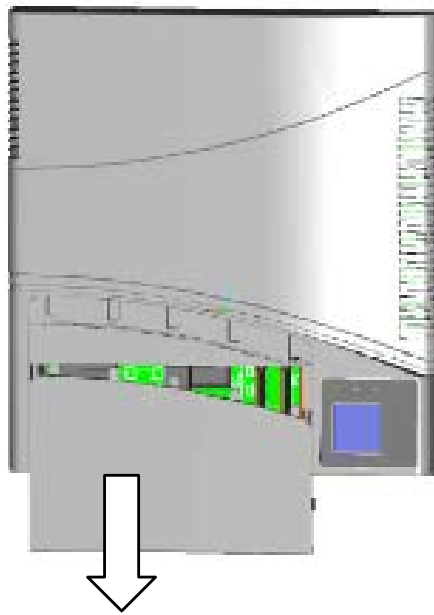

Fig. 6 How to open the panel

- 2) Use the metal support bar to determine where to drill the wall. Drill the holes, install the expansion screws and mount the support bar against the wall.
- 3) Hang AURORA to the metal support in order to determine the location of the third hole, remove AURORA, drill the third hole, install the expansion screw, hang AURORA to the support bar again and secure it with the third screw (Fig. 7)
- 4) Mount the panel again and close it by using the TX10 tap wrench provided.

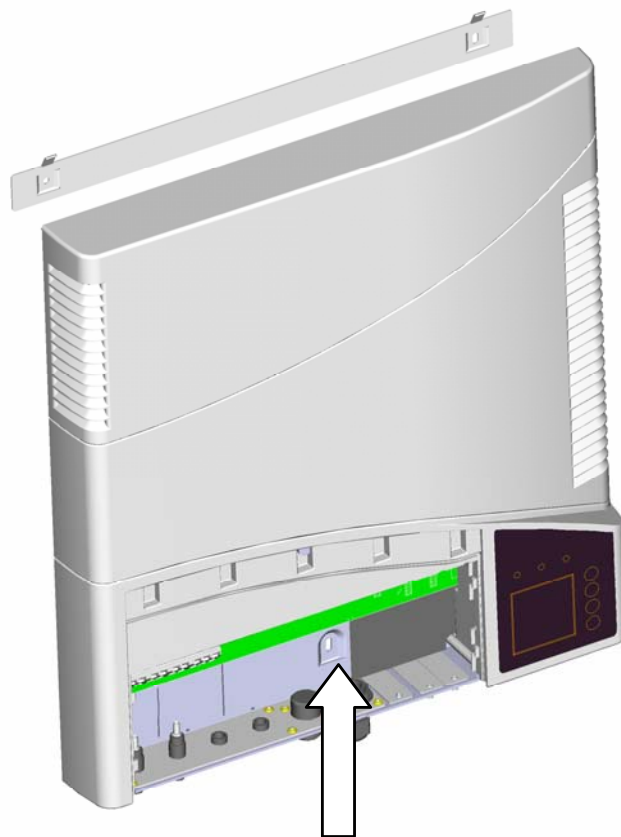

Fig. 7 Location for the third screw

### 3.5 Preliminaries to Electrical Connections



**WARNING:** The electrical connections can be done only after securing AURORA to the wall.



**WARNING:** The connection of AURORA to the electrical distribution grid must be performed only by skilled operators and after having received authorization from the utility that operates the grid.



**WARNING:** For further details on each installation step, carefully read and follow the instructions of this section (and sub-sections) step-by-step, as well as all safety warnings. Any operation non-complying with the instructions below can lead to operator/installer hazards and to equipment damage.



**WARNING:** Always respect the nominal ratings of voltage and current defined in chapter 8 (Technical Features) when designing your system. In particular, regarding the photovoltaic system:

- Maximum Dc array input voltage for each MPPT circuit: 600Vdc in any condition.
- Maximum Dc array input current for MPPT circuit: 10A<sub>dc</sub> in any condition.





**WARNING:** Verify the national regulations and the local standards, to make sure that your installation design complies to them.



**WARNING:** carefully cover the entire surface of the photovoltaic panels with an opaque material (possibly black) to protect them from sun radiation.



**NOTE:** According to the typical assembly diagram (see Fig.8) each array must be connected to Dc disconnect. An AC disconnecting mean provided with fuses or an over-current protection must be used to connect AURORA to the grid. Although the fuses are not mandatory, should you choose to use a Power-One-approved over-current protection, we recommend insetting them in the system.

Recommended ratings for the Ac over-current protection device is maximum 10A, 240V.

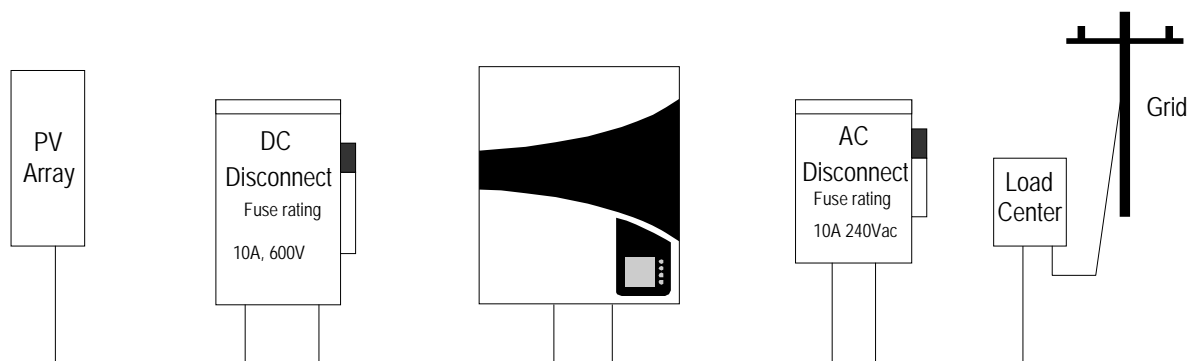

Fig.8 General wiring diagram



**WARNING:** always open the AC disconnect breaker to disconnect AURORA from the grid before opening the DC disconnect.



**WARNING:** All power wires connecting AURORA must have a section of at least 14 AWG (2.5mm<sup>2</sup>) and must be able to operate at temperature of at least 90 °C.

We recommend using the following types of wires:

For connecting the panels: FG7 (0)R unipolar wire, or H07RNF wire with sections 2.5; 4; or 6 mm<sup>2</sup> with an external diameter of max. 8,9mm.

For connecting to the grid: FG7(0)R tripolar wire with a section of 2.5 or 4 mm<sup>2</sup> with an external diameter of max 16,2mm.

At the bottom of the inverter, from left to right, (Fig. 9 and Fig. 10) there are:

- 1 pairs of multicontact MC3 connectors for connecting the photovoltaic array
- 1 Binder connector for connection to the grid
- 1 closed hole with watertight cap. This hole may be used for connecting a serial wire for data transmission, once you have removed the cap and replaced it with the wire gland provided.

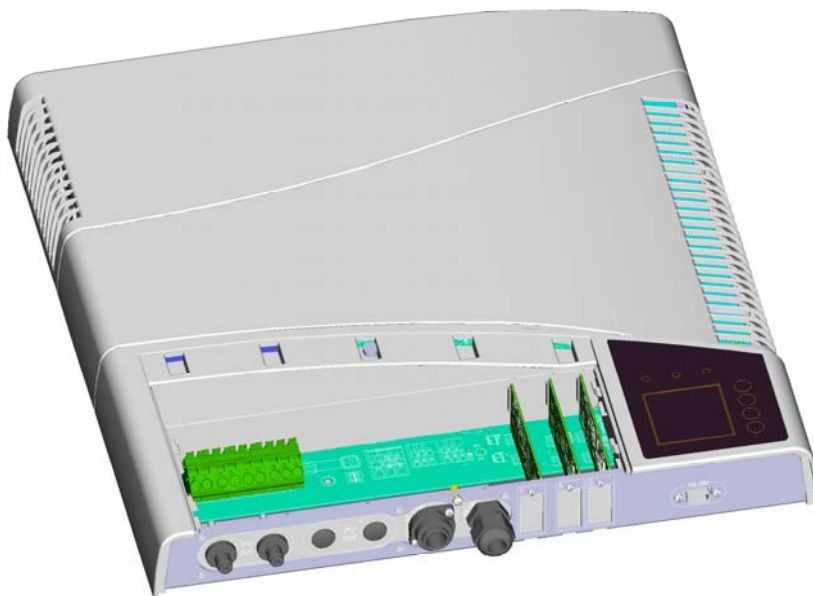

Fig. 9 Connections at the bottom of the inverter

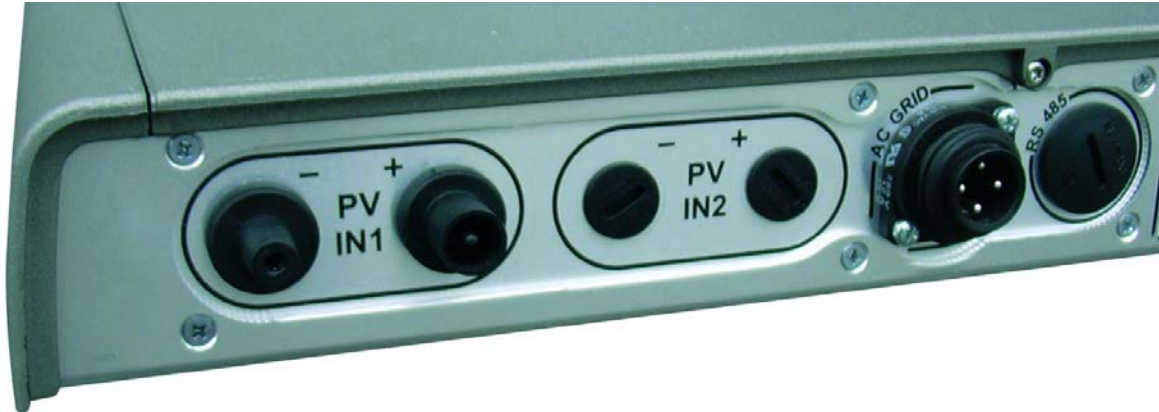

Fig. 10 Connector inputs



**WARNING:** When making the electrical connections, follow this exact procedure to avoid exposure to dangerous voltage. Each step of the procedure is explained in the following paragraphs. To disconnect AURORA repeat the procedure in opposite order.

### 3.6 Electrical connections

#### Step 1/4: Open the Ac disconnect switch

#### Step 2/4: Open the Dc disconnect switch

#### Step 3/4: Connect AURORA to the Ac disconnect switch



**WARNING:** Use proper, low impedance wires to connect AURORA to the Ac disconnect.



**WARNING:** AURORA must be connected to the AC disconnect switch with a tripolar wire: a phase conductor, a neutral conductor and a yellow-green one for the earth connection (PE protection).

- 1) Lay the wire between AURORA and the Ac disconnect switch
- 2) Enter the wire in the Binder counterpart connector provided, taking care to respect the indications present on the plastic near the terminal blocks (as indicated in Fig. 11): terminal block 1 for Neutral, terminal block 2 for the line, terminal block 3 not connected, and the terminal block identified by the  symbol for the PE earth connection.
- 3) Connect the Binder connector

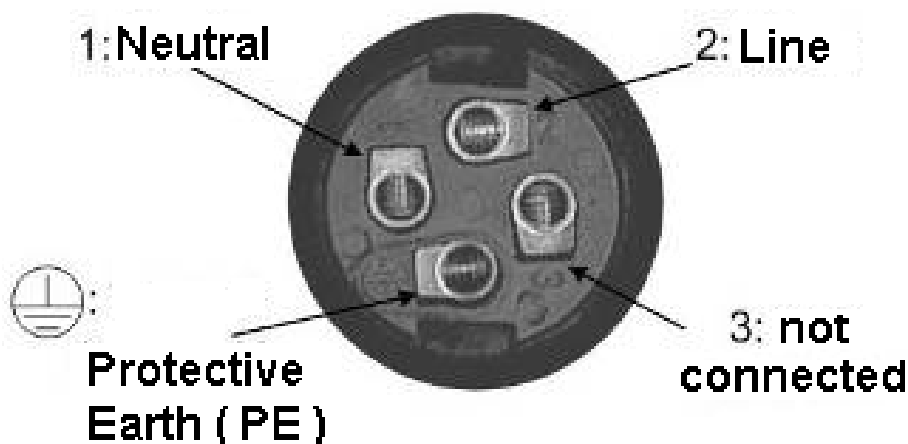

Fig. 11 Binder connector



**WARNING:** Pay special attention at not inverting the phase with the neutral because it could compromise the system safety and cause malfunctioning of the appliance.



**NOTE:** In case your system has an additional kW-hour metre installed between the Ac disconnect and AURORA, please apply the Ac connection procedure to the terminals of the metre.

#### **Step 4/4: Connect AURORA to the Dc disconnect switches**

Power-One recommends, whenever it is possible, to use two separate arrays, each with a current capacity lower than 10A<sub>dc</sub>, and to connect each array to an input section of the AURORA inverter.



**WARNING:** Take special care to ensure the photovoltaic voltage polarity corresponds to the symbols “+” and “-” labelled on the contacts of the photovoltaic field.

Before connecting AURORA with the photovoltaic field, Power-One recommends checking, using a proper gauge, that the polarity value and the voltage value allowed between positive and negative contacts are correct.

Array connection: Follow this procedure for each array.

- 1) Mount the positive conduit between AURORA and the Dc disconnect.
- 2) Secure the conduit to the counterpart multicontact connector (not provided)
- 3) Connect the positive conduit to AURORA
- 4) Mount the negative conduit between AURORA and the Dc disconnect.
- 5) Secure the conduit to the counterpart multicontact connector (not provided)
- 6) Connect the negative conduit to AURORA

## 4 START-UP



**WARNING:** Do not lay any object on AURORA during operation.

To start AURORA up, close the two external disconnect switches, and precisely that of the PV panels and that of the grid. The two disconnect switches can be closed in any order. Once the two switches have been closed, the inverter, if there are not irregularities, AURORA will start the grid connection sequence, indicated by the flashing green LED on the display and by the messages shown on the LCD display. The sequence can last from a minimum 30 seconds to a few minutes, depending on the conditions of the grid and photovoltaic field. Once the connection sequence has been completed, AURORA is put into operation. The green LED lit continuously indicates the correct operation.

After the start-up, AURORA operates automatically and is maintenance-free.

When solar radiation is not high enough to provide power to export to the grid AURORA will disconnect from the grid and enter the stand-by mode, ready to connect again once the solar irradiation will be sufficient.

During the night AURORA will remain off ready to start up again automatically the following morning.

## 5 MONITORING AND DATA TRANSMISSION

### 5.1 User Interface Mode



**WARNING:** The RS-485 wire must ensure a protection of at least 600V.

AURORA inverter can provide operational data in the following ways:

- LED indicators
- Operational data on the LCD display
- Data transmission on a dedicated serial RS-485 line or RS-232 line. The data can be collected by a PC or data logger equipped with a suitable RS-485 or RS-232 port. In case you use the RS-485 line, a RS-485/RS-232 AURORA serial interface converter model number PVI-RS232485 can be useful. You can also use the AURORA Easy Control (\*) data logger.

(\*) Please check if this accessory is available with your installer or retailer.

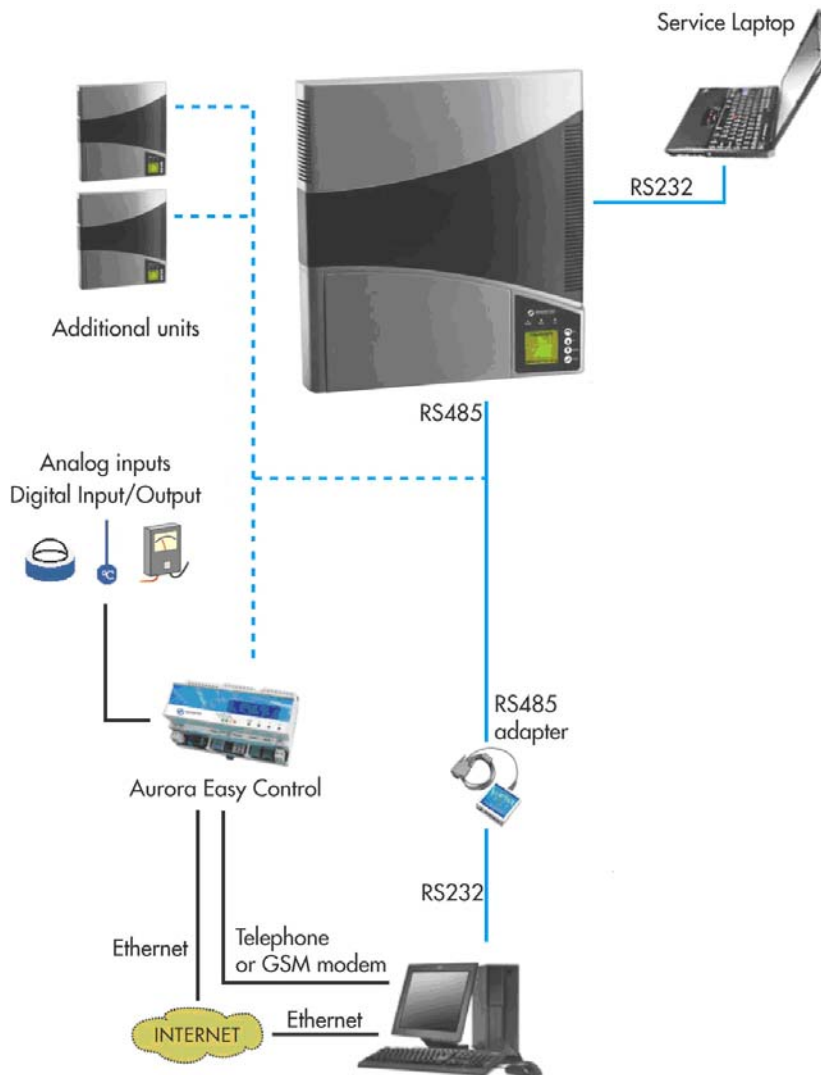

Fig.12 - Comunicazione dati a Aurora



## 5.2 Available Data

AURORA provides two sets of data that are accessed using AURORA interface software.

### 5.2.1 Real time data

The real time operating data can be transmitted upon request over the communication lines and is not recorded internally by the AURORA inverter. The free AURORA Communicator interface software, provided on the installation CD can be used to retrieve and store data on a PC computer (please check on [www.power-one.com](http://www.power-one.com) for updated versions).

The following data are available:

- Grid frequency
- Power transferred to the grid
- Voltage of PV array 1
- Current of PV array 1
- Voltage of PV array 2
- Current of PV array 2
- Heat sink temperature
- Serial Number Part Number
- Manufacturing week
- Firmware revision code
- Energy produced so far in the day
- Leakage Current

### 5.2.2 Internally Logged Data

AURORA stores internally the following data:

- Lifetime counter of grid connection time
- Lifetime counter of energy transferred to the grid
- Energy transferred to the grid every 10 seconds for the last 8640 periods of 10 seconds (which on average cover more than 2 days logged data)
- Partial counter of grid connection time (the counter start time can be reset by using the AURORA Communicator software)
- Partial counter of energy (uses the same start time of the partial time counter)
- Last 100 fault conditions with error code and time stamp
- Last 100 variations to the grid connection parameters with parameter code, new value.

The first two data of the list are displayed on the LCD and on the RS-485 interface, while all the other data can be shown by the RS-485 interface only.

### 5.3 LED Indicators

Above the display there are three LED indicators: one to indicate whether the inverter is operating regularly, one to signal the presence of faults and one to indicate a ground fault.

1. The green "POWER" LED indicates that AURORA is working correctly. When the unit is powered on this led is blinking while the grid is checked. If the grid parameters are within the normative limits and there is enough solar energy, the unit starts to export energy to the grid and the LED is on. If, on the other hand, the sun is too low, the LED keeps blinking and the LCD shows the message "waiting for sun."
2. The yellow "FAULT" LED indicates that AURORA has detected a fault. The type of fault will be described in the LCD display.
3. The red "GFI" (ground fault) LED indicates that AURORA has detected a ground fault in the PV system on the DC side. When this type of fault is detected, AURORA immediately disconnects from the Grid and an error message appears on the display. AURORA will remain in that status until the operator presses ESC to restart the connection sequence. If AURORA does not connect and a Ground Fault is detected again technical assistance should be contacted to review the overall system for the ground fault condition.



Fig.14 LED location

**KEY:**

- LED on
- LED flashing
- LED off
- Any of the above conditions

	LEDs Status	Operational Status	Remarks
1	green: ☒ yellow: ☒ red: ☒	Aurora self-disconnection during nighttime	Input voltage less than 90 Vdc at both inputs
2	green: ◼ yellow: ☒ red: ☒	Aurora initialization, settings loading and waiting for grid check	It is a transition status while operating conditions are checked.
3	green: ◼ yellow: ☒ red: ☒	Aurora is powering the grid	Standard machine operation (search of max. power point or constant voltage).
4	green: ◻ yellow: ◻ red: ◼	System insulation device faulty	Ground leakage found
5	green: ☒ yellow: ◼ red: ☒	Defect – fault!!!	The Fault can be inside or outside the machine. See the alarm appearing on the LCD.
6	green: ☒ yellow: ◼ red: ☒	Installation phase: Aurora is disconnected from grid.	During installation, it refers to set-up of the address for RS-485 communication.
7	green: ☒ yellow: ◼ red: ☒	Grid disconnection	Indicates a missing grid condition



**NOTE:** Every inverter status signalled by the corresponding LED turning on or blinking, is also identified on AURORA LCD display by a message concerning the operation being carried out or to the defect/fault found (see following sub-sections).

- 
- G**  **1) Nighttime mode**  
**Y**  AURORA disconnected during night time; this occurs when input power  
**R**  is too low to feed the inverter.
- G**  **2) AURORA initialization and grid check**  
**Y**  Initialization in progress: input power sufficient to feed the inverter;  
**R**  AURORA is verifying start-up conditions (for instance: input voltage  
value, insulation resistance value, etc.) and grid check routine is  
launched.
- G**  **3) AURORA is feeding the grid**  
**Y**  After completing a set of electronics and safety auto-test routines, the  
**R**  inverter starts the grid connection process.  
As mentioned above, during this stage AURORA automatically tracks  
and analyzes the maximum power point (MPPT) of the photovoltaic  
field.
- G**  **4) Ground insulation fault**  
**Y**  AURORA indicates that insulation resistance was found to be too low.  
**R**  This may be due to an insulation fault in the connection between the  
photovoltaic field inputs and the ground.



**WARNING:** Shock hazard! Do not attempt to correct this fault yourself. The instructions below have to be followed very carefully. In case you are not experienced or skilled enough to work safely on the machine, contact a specialized technician.

**What to do after an insulation defect has been found**

When the red LED turns on, try to reset the fault indication by pressing the multi-function ESC key at the side of the display. If AURORA reconnects to the grid, the fault was due to a transient event (such as condensation and moisture getting into the panels). If this trouble occurs frequently, have the system inspected by a specialized technician.

If AURORA does not reconnect to the grid, open both the DC and AC disconnect switches to place AURORA into a safe condition and contact an authorized service center to have the system repaired.

- G**  **5) Malfunction/Fault indication**  
**Y**  Every time Aurora check system detects an operative malfunction or  
**R**  fault of the monitored system, the yellow LED comes on and a message  
showing the type of problem found appears on the LCD.

---

**G**  **6) RS-485 address setup indication**

**Y**  During installation, the yellow LED will keep flashing until the address is acknowledged. For further information about address entering, refer to section 6.3.

**R**

**G**  **7) Grid disconnection**

**Y**  If a grid failure event occurs while the system is regularly operating, the yellow LED turns on steady.

**R**

## 5.4 Messages and Error Codes

The system status is identified through message or error signals appearing on the LCD display.

The tables below summarise the two types of signals that can be displayed.

MESSAGES identify the AURORA current status; so they do not relate to faults and nothing has to be done. The message will disappear as soon as standard conditions are restored. See the Warning column (W) in the table below.

ERRORS identify a possible fault of the equipment or of the connected parts. The signal will disappear as soon as the causes are removed, except for the ground insulation fault on photovoltaic panels, for which the intervention of qualified personnel is required. Usually, when an error signal appears, an action is needed. This action will be managed as much as possible by AURORA or, in case this is not possible, AURORA will supply all the necessary information to assist the person fixing the fault on the equipment or system. See the Error column (E) in the table below.



<b>Alarm n.</b>	<b>Message</b>	<b>Warning code</b>	<b>Error code</b>	<b>Description</b>
1	Sun Low	W001	//	Input voltage under threshold ( when OFF )
2	Input OC	//	E001	Input Over current
3	Input UV	W002	//	Input Undervoltage
4	Input OV	//	E002	Input Overvoltage
6	Int.Error	//	E003	No parametres
7	Bulk OV	//	E004	Bulk Overvoltage
8	Int.Error	//	E005	Communication error
9	Out OC	//	E006	Output Overcurrent
10	Int. Error	//	E007	IGBT Sat
11	Int.Error	//	E008	Bulk Undervoltage
12	Int.Error	//	E009	Internal error
13	Grid Fail	W003	//	Incorrect grid parametres
14	Int.Error	//	E010	Bulk Low
15	Int.Error	//	E011	Ramp Fail
16	DC/DC Fail	//	E012	DcDc error detected by the inverter
17	Wrong Mode	//	E013	Incorrect input setting (single instead of dual)
18	-----	//	//	-----
19	Over Temp.	//	E014	Internal overtemperature
20	Cap. Fault	//	E015	Bulk capacitor fail
21	Inv. Fail	//	E016	Inverter fail detected by the DcDc
22	Int.Error	//	E017	Start Timeout
23	Ground F.	//	E018	Ileak fail
24	-----	//	//	-----
25	Int.Error	//	E019	Ileak sensor fail
26	DC/DC Fail	//	E012	DcDc error detected by the inverter
27	Int.Error	//	E020	inverter relay fail
28	Int.Error	//	E021	DcDc relay fail
29	Int.Error	//	E019	Ileak sensor fail
30	Int.Error	//	E022	Autotest Timeout
31	Int.Error	//	E023	Dc-Injection Error
32	Grid OV	W004	//	Output Overvoltage
33	Grid UV	W005	//	Output Undervoltage
34	Grid OF	W006	//	Output Overfrequency
35	Grid UF	W007	//	Output Underfrequency
36	Z Grid HI	W008	//	Z grid out of range
37	Int.Error	//	E024	Internal error
38	-----	//	E025	Low insulation resistance ( log only )
39	Int.Error	//	E026	Wrong reference voltage (VRef)
40	Int.Error	//	E027	Wrong grid voltage measurement ( VGrid )
41	Int.Error	//	E028	Wrong grid frequency measurement ( FGrid )
42	Int.Error	//	E029	Wrong grid impedance

---

				measurement ( ZGrid )
43	Int.Error	//	E030	Wrong leakage current measurement (ILeak)
44	Int.Error	//	E031	Wrong voltage measurement V
45	Int.Error	//	E032	Wrong current measurement I
46	Fan Fail	W010	//	Defective Fan ( log only )
47	Int.Error	//	E033	Internal temperature

## 5.5 LCD Display

The display monitors the inverter status and collects statistical data that allows assessing the system performances. On the right side of the display there are 4 buttons (from bottom to top):

- ✓ The ENTER button allows to confirm the user selection
- ✓ The “UP” and “DOWN” buttons, allow you to browse through the various menus and to enter alphanumeric data required.
- ✓ The “ESC” button allows going back to the previous menu.

Upon power-on the Power-One logo appears on the display.



After a few seconds the following display image will appear:

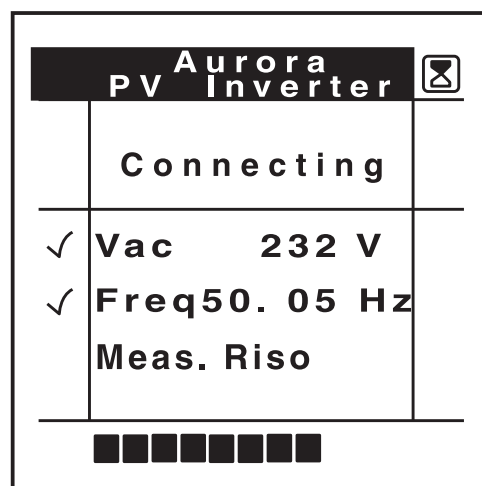

While Aurora is measuring the grid and photovoltaic field characteristics the following measurements are shown:

<b>Grid voltage</b>	<b>Vac</b>
<b>Grid frequency</b>	<b>Freq</b>
<b>Photovoltaic panel isolation resistance</b>	<b>Riso</b>

When the measurement is within the normative limits the symbol *V* will appear on the left.

This screen image remains on until the inverter is ready to connect to the grid. A progress bar will appear in the lower part of the screen.

Once the inverter is connected to the grid the following screen will appear on the display:

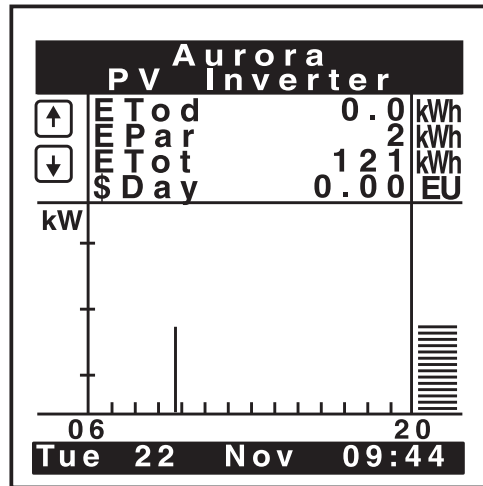

In the upper right corner there is an icon indicating the solar irradiation condition: it can show either a little sun, or a cloud or a sun covered by a cloud.

---

In the upper part of the display are shown the most important parameters of the inverter; using the UP and DOWN buttons it is possible to visualise the following parameters:

- EDay: Energy exported to the grid during the current day.
- EPar: Energy partial counter (user settable).
- ETot: counter of the total energy exported to the grid
- \$Day: value of the energy produced during the day (The currency and the energy value per KW-h can be set by the user)
- Pout: power exported to the grid;
- Vout: Grid Voltage;
- Iout: current exported to the grid;
- Freq: grid frequency;
- VP: Voltage for array;
- IP: current from array;
- Pin: power from array;
- Riso: isolation resistance of the Photovoltaic input circuit.
- Tamb: Ambient temperature.

In the lower part of the display is shown the graph of the power exported to the grid during the day from 6AM to 8 PM. (the time scale may be modified by the user).

A window on the right-hand-side of the graph will show the power exported to the grid.

In the lower part of the display are shown the default date and time. Any variations due to time zones or daylight saving time must be made manually by the user.

By pressing "ESC" you access the "**Main Menu**" with three different sections:

- ✓ STATISTICS
- ✓ SETTINGS
- ✓ INFORMATION

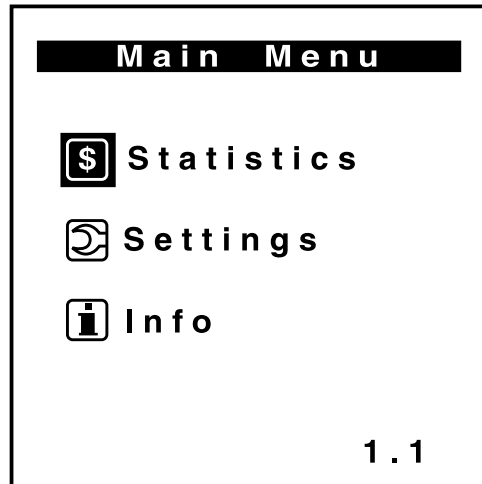

Select the desired section by pressing UP and DOWN and confirm your selection by pressing ENTER. This way you access the relative sub-menu. Press ESC to return to the main menu.

### 5.5.1 Statistics menu

The STATISTICS submenu displays a series of data regarding different intervals of time:

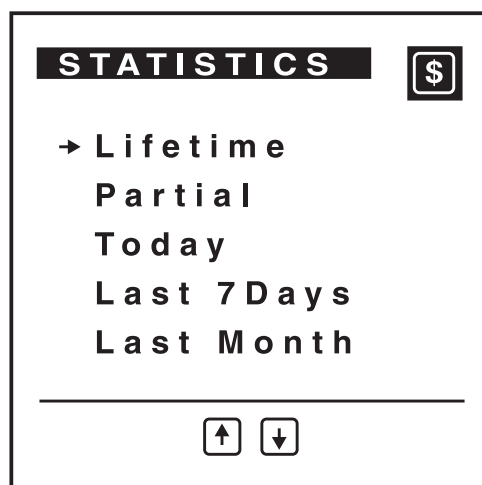

### 5.5.1.1 Total

Press the UP or DOWN button until you reach TOTAL. By pressing ENTER the display will show the following lifetime data regarding the inverter:

- Time: total time during which the inverter has been operating, whether connected to the grid or not (h)
- Energy: Energy exported to the grid (kWh)
- Savings: Value of the energy produced, the currency and the energy cost per kWh can be set by the user
- CO2: Quantity of CO2 saved compared to the energy produced using fossil fuels (kg).

<b>Lifetime</b>		<b>\$</b>
<b>Time</b>	<b>87 h</b>	
<b>Energy</b>	<b>166 KWh</b>	
<b>Savings</b>	<b>0 EUR</b>	
<b>CO2</b>	<b>94 Kg</b>	

### 5.5.1.2 PARTIAL

Press the UP or DOWN button until you reach TOTAL. By pressing ENTER the display will show the following data referring to a partial interval of time resettable by the user:

- Time: partial time during which the inverter, has been operating, whether connected to the grid or not (h)
- Energy: Energy exported to the grid (kWh)
- Saving: Value of the energy produced, the currency and the energy cost per kWh can be set by the user
- CO2: Quantity of CO2 saved compared to the energy produced using fossil fuels (kg).

Press ENTER to reset the counter

<b>Partial</b>		<b>\$</b>
<b>Time</b>		<b>11 h</b>
<b>Energy</b>	<b>22 KWh</b>	
<b>Savings</b>	<b>0 EUR</b>	
<b>CO2</b>	<b>13 Kg</b>	
	<b>↩</b>	<b>= Res</b>



5.5.1.3 *TODAY*

Press the UP or DOWN button until you reach TOTAL. By pressing ENTER the display will show the following data referring to the day in progress:

- Energy: Energy exported to the grid (kWh)
- Savings: Value of the energy produced, the currency and the energy cost per kWh can be set by the user
- CO2: Quantity of CO2 saved compared to the energy produced using fossil fuels (kg).

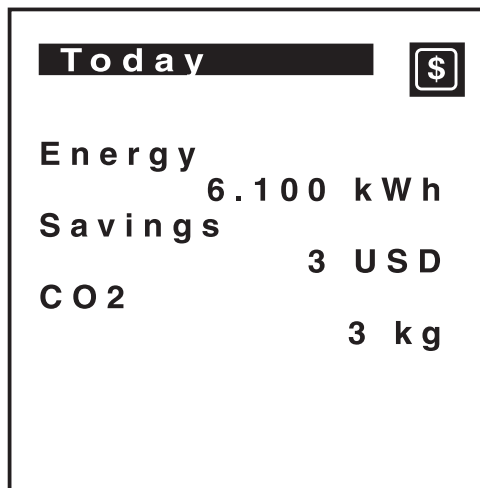

#### 5.5.1.4 LAST 7 DAYS

Press the UP or DOWN button until you reach TOTAL. By pressing ENTER the display will show the following data referring to the last week:

- Energy: Energy exported to the grid (kWh)
- Savings: Value of the energy produced, the currency and the energy cost per kWh can be set by the user
- CO2: Quantity of CO2 saved compared to the energy produced using fossil fuels (kg).
- Graph of the energy produced in the past 7 days.

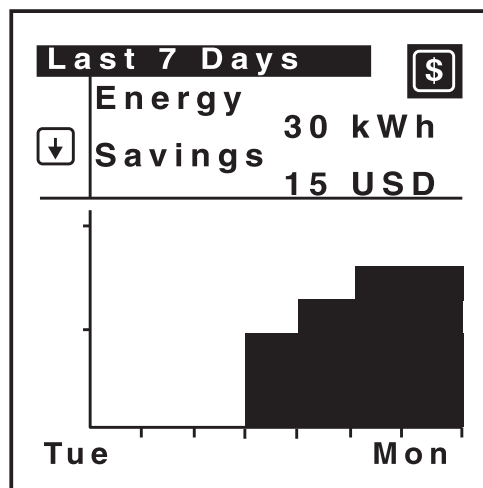

### 5.5.1.5 LAST MONTH

Press the UP or DOWN button until you reach TOTAL. By pressing ENTER the display will show the following data referring to the past calendar month:

- Energy: Energy exported to the grid (kWh)
- Saving: Value of the energy produced, the currency and the energy cost per kWh can be set by the user
- CO2: Quantity of CO2 saved compared to the energy produced using fossil fuels (kg).
- Graph of the energy produced in the past month.

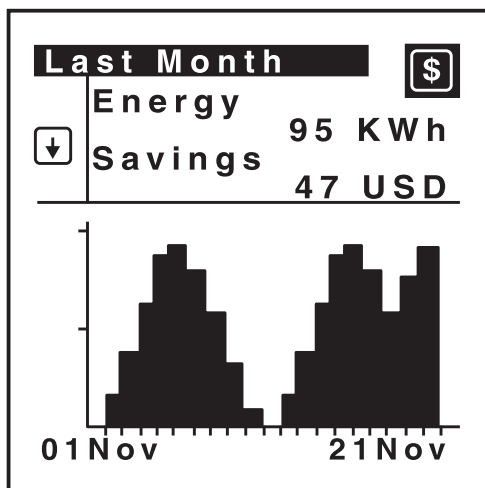

### 5.5.1.6 LAST 30 DAYS

Press the UP or DOWN button until you reach TOTAL. By pressing ENTER the display will show the following data referring to the past 30 days:

- Energy: Energy exported to the grid (kWh)
- Saving: Value of the energy produced, the currency and the energy cost per kWh can be set by the user
- CO2: Quantity of CO2 saved compared to the energy produced using fossil fuels (kg).
- Graph of the energy produced in the past 30 days

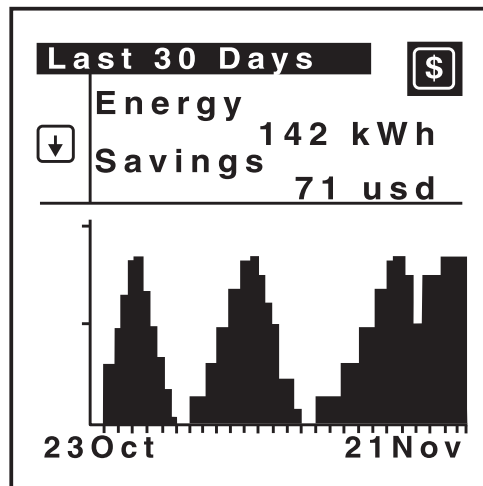

### 5.5.1.7 LAST 365 DAYS

Press the UP or DOWN button until you reach TOTAL. By pressing ENTER the display will show the following data referring to the past year:

- Energy: Energy exported to the grid (kWh)
- Saving: Value of the energy produced, the currency and the energy cost per kWh can be set by the user
- CO2: Quantity of CO2 saved compared to the energy produced using fossil fuels (kg).
- Graph of the energy produced in the past 365 days

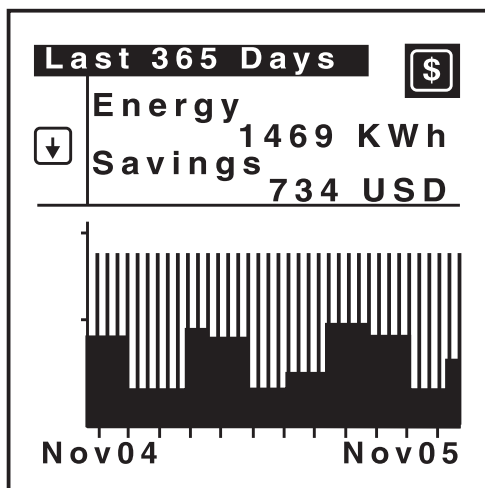

### 5.5.1.8 USER PERIOD

Press the UP or DOWN button until you reach TOTAL. By pressing ENTER the display will show a screen for setting the period of reference for displaying the data. You can modify the days and the months by using the UP and DOWN buttons and confirming by pressing ENTER.

A second screen image will appear containing the following data referring to the selected period of time:

- Energy: Energy exported to the grid (kWh)
- Saving: Value of the energy produced, the currency and the energy cost per kWh can be set by the user
- CO2: Quantity of CO2 saved compared to the energy produced using fossil fuels (kg).
- Graph of the energy produced in the selected period of time.

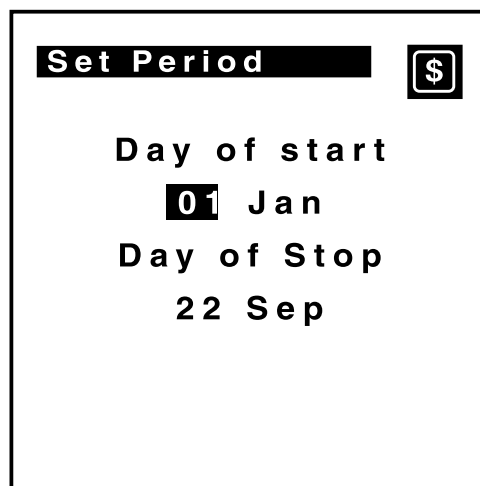

### 5.5.2 Settings menu

By selecting the SETTINGS menu from the main menu, a screen image requiring a password will appear.

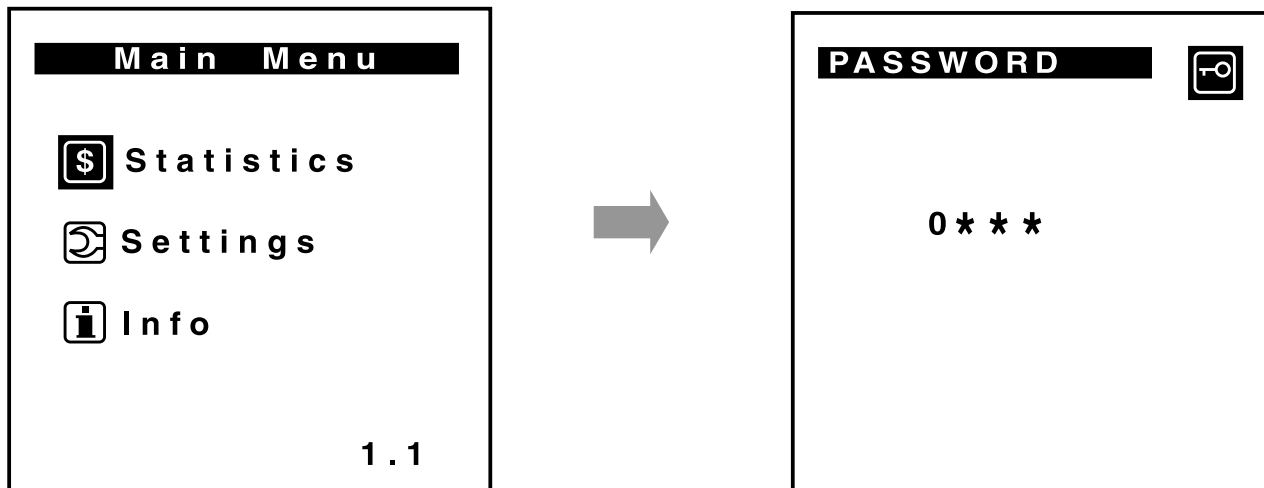

The password is composed of 4 numeric digits (by default “0000”) which can be set by the user as described below. Each numeric digit is selected by pressing UP and DOWN and confirmed by pressing ENTER. By pressing “ESC” you can go back and modify the previously selected digit.

If the password is correct, the menu for the parametre configuration will appear after the last ENTER:

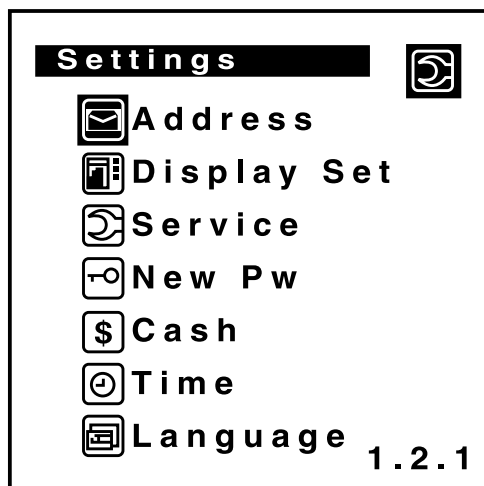

**NOTE:** If the password is incorrect, the message “ERROR – INCORRECT PW” will appear for approximately 3 seconds.

### 5.5.2.1 ADDRESS

Starting from the SETTINGS menu, press UP and DOWN until you reach ADDRESS. By pressing ENTER, the window for selecting the address for the RS485 s display (values between 0 and 31).

Use the UP and DOWN buttons to select the value to be entered and press ENTER to confirm.

To return to the SETTINGS submenu, press ESC.

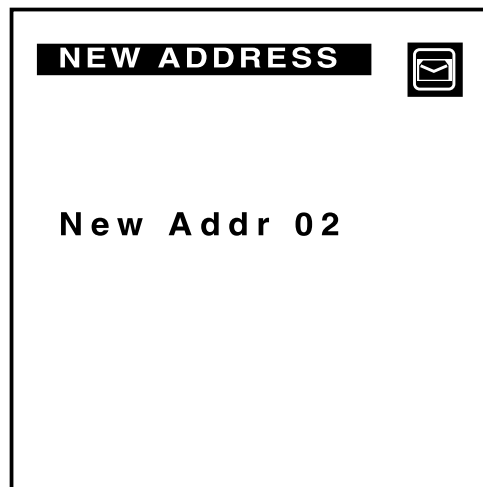

### 5.5.2.2 DISPLAY SETTING

Starting from the SETTINGS menu, press UP and DOWN until you reach DISPLAY SETTING. By pressing ENTER the window for setting the display mode will appear on the display.

Use the UP and DOWN buttons to select the display mode and press ENTER to confirm. To return to the SETTINGS submenu, press ESC.



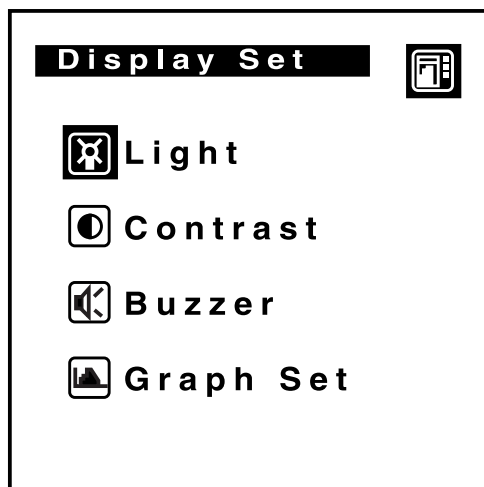

### 5.5.2.2.1 LIGHT

From the DISPLAY SETTING menu, select the LIGHT mode using the UP and DOWN buttons. By pressing ENTER, the window for setting the brightness of the display will appear on the display.

Use the UP and DOWN buttons to select the parametre to be modified and press ENTER to confirm.

Mode: Illumination can be set on ON, OFF or AUT

Intensity: The light intensity can be also modified using the UP and DOWN buttons (values from 0 to 9).

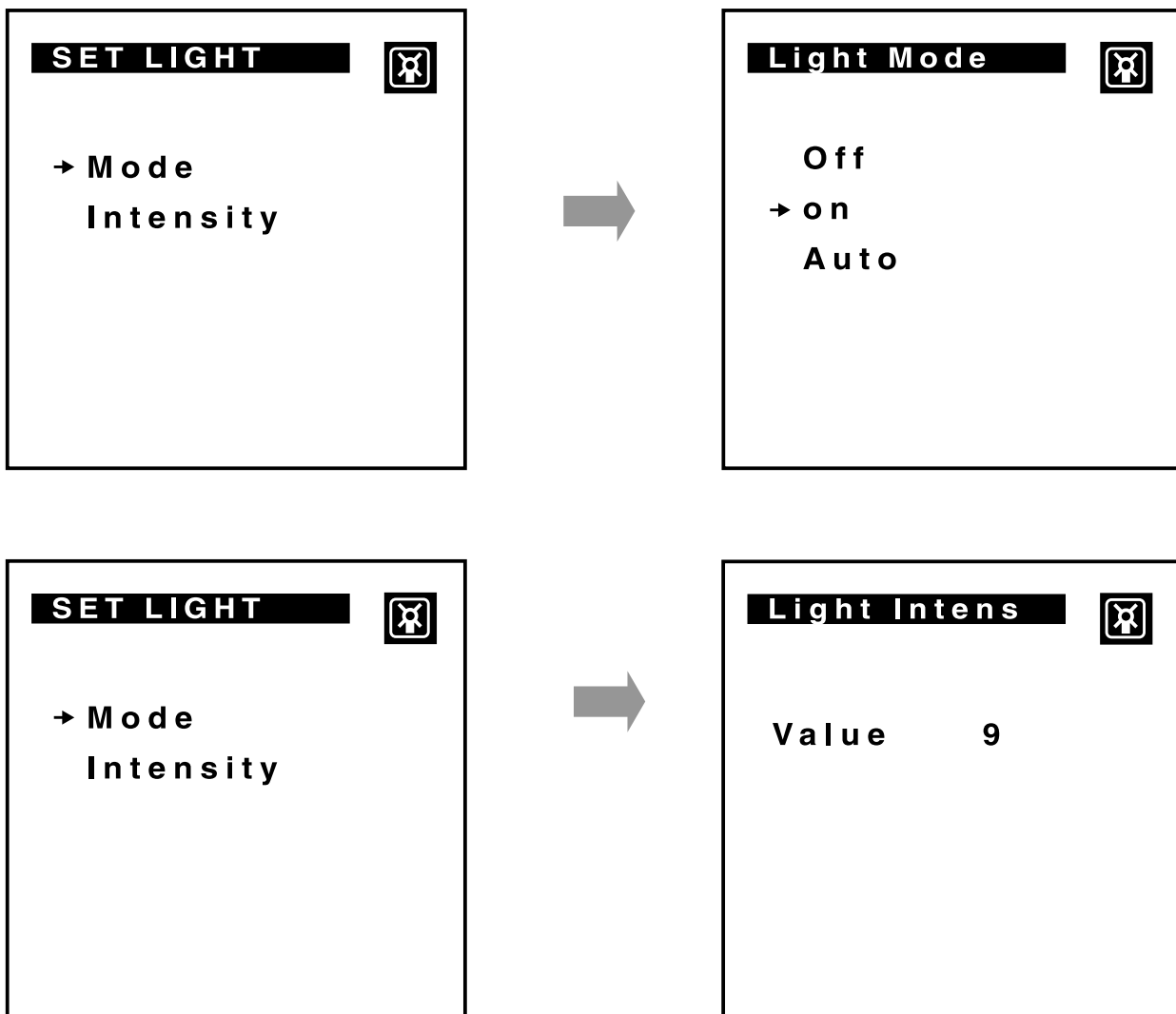

To return to the DISPLAY SETTING submenu, press ESC.

---

#### 5.5.2.2.2 *CONTRAST*

From the DISPLAY SETTING menu, select the CONTRAST mode using the UP and DOWN buttons. By pressing ENTER, the window for setting the contrast of the display will appear.

Use the UP and DOWN buttons to modify the value (from 0 to 9) and press ENTER to confirm.

To return to the DISPLAY SETTING submenu, press ESC.

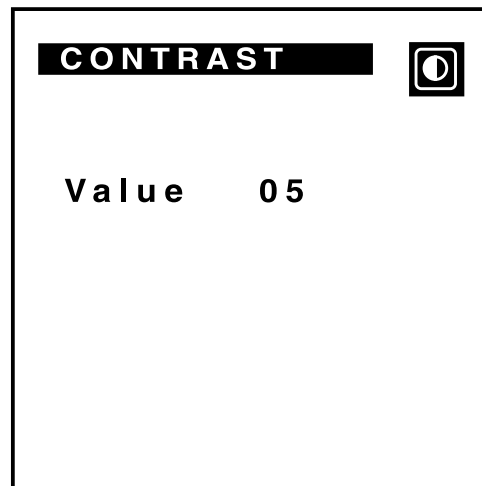

#### 5.5.2.2.3 *BUZZER*

From the DISPLAY SETTING menu, select the BUZZER mode using the UP and DOWN buttons. By pressing ENTER, the window for enabling or disabling the sound when you press any key.

Use the UP and DOWN buttons to activate or deactivate the sound and press ENTER to confirm.

To return to the DISPLAY SETTING submenu, press ESC.

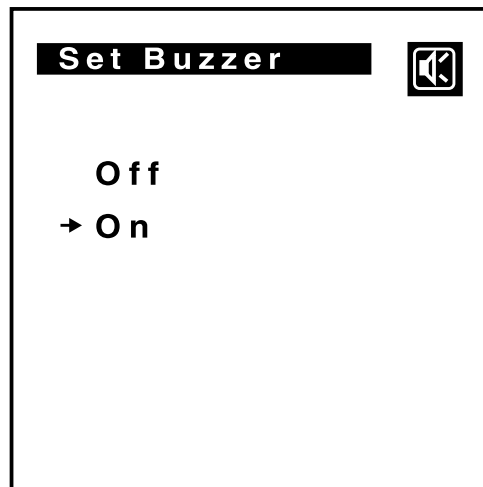

#### 5.5.2.2.4 GRAPH SET

From the DISPLAY SETTING menu, select the GRAPH SET mode using the UP and DOWN buttons. By pressing ENTER, the window for setting the interval of time to which the graph in the MAIN MENU refers to, will appear on the display.

Use the UP and DOWN buttons to modify the dates shown on the display and press ENTER to confirm.

To return to the DISPLAY SETTING menu, press ESC.

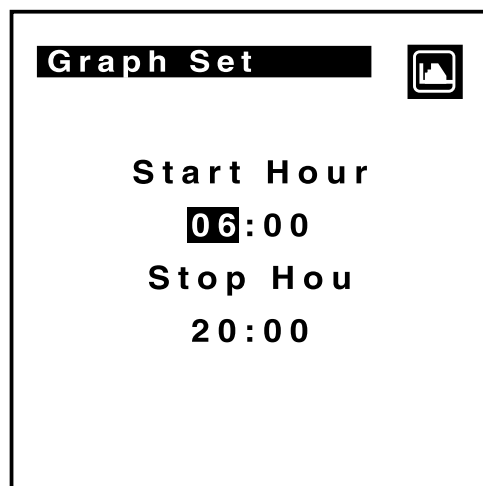

To return to the SETTINGS menu from the DISPLAY SETTINGS submenu, press ESC.

### 5.5.2.3 SERVICES



**NOTE:** The service menu is for qualified and authorised technicians only. Therefore, no information on the use of this menu will be provided in this user guide.

### 5.5.2.4 CHANGE PW

From the SETTINGS menu, use the UP and DOWN buttons to select the NEW PW mode in order to modify the password to access the menu. By pressing ENTER, the screen image requiring the new password will appear.

Use the UP and DOWN buttons to enter the new password and press ENTER to confirm.

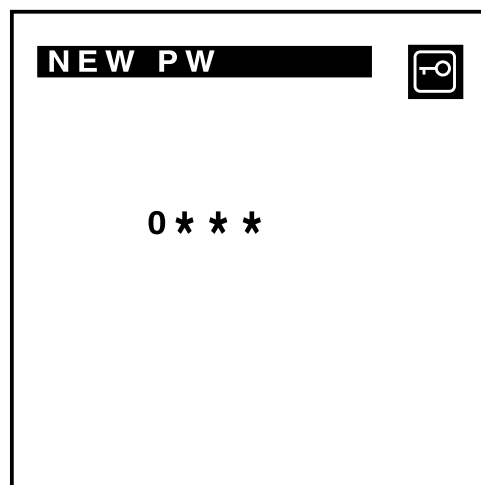

### 5.5.2.5 CURRENCY

From the SETTINGS menu, use the UP and DOWN buttons to select the CURRENCY mode. By pressing ENTER, the window for setting the monetary value of a Wh will appear, in order to quantify the energy saving.

Name: currency name (3 characters)

Val./kWh: value for kWh

Use the UP and DOWN buttons to modify the value and press ENTER to confirm.

To return to the SETTINGS menu, press ESC.

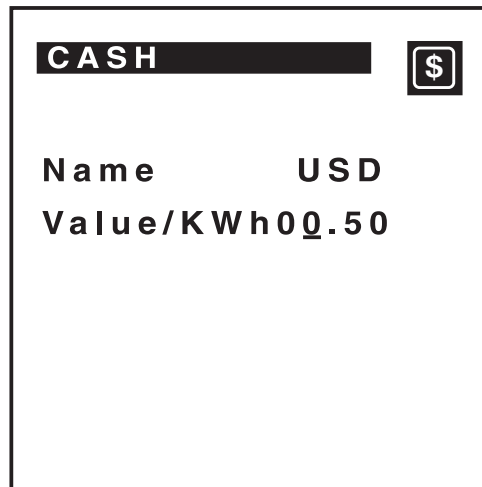

The screenshot shows a terminal window with the following text:

```
CASH [DOLLAR SIGN]
Name      USD
Value/KWh 00.50
```

### 5.5.2.6 *CLOCK*

From the **SETTINGS** menu, use the **UP** and **DOWN** buttons to select the **CLOCK** mode. By pressing **ENTER**, the screen image for setting the current time and date will appear on the display.

Use the **UP** and **DOWN** buttons to modify the data and press **ENTER** to confirm. Upon confirmation of the last datum, the new data will be stored and the **SETTINGS** menu will appear.

To return to the **SETTINGS** menu without saving the data, press **ESC**.

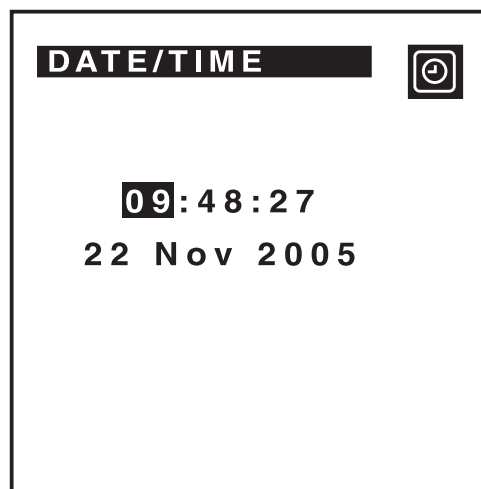

### 5.5.2.7 LANGUAGE

From the SETTINGS menu, use the UP and DOWN buttons to select the LANGUAGE mode. By pressing ENTER, the window for setting the language will appear on the display.

Use the UP and DOWN buttons to select the language of the display and press ENTER to confirm.

To return to the SETTINGS menu without saving the data, press ESC.





### 5.5.3 Information menu

By selecting the INFORMATION menu from the main menu, a screen image will appear containing machine identification information. These data are useful for the technical assistance to identify the product and solve any problems.

- Product Id: provides the production identification code of the inverter
- Serial number: provides the serial number, the week and the year of production
- Firmware

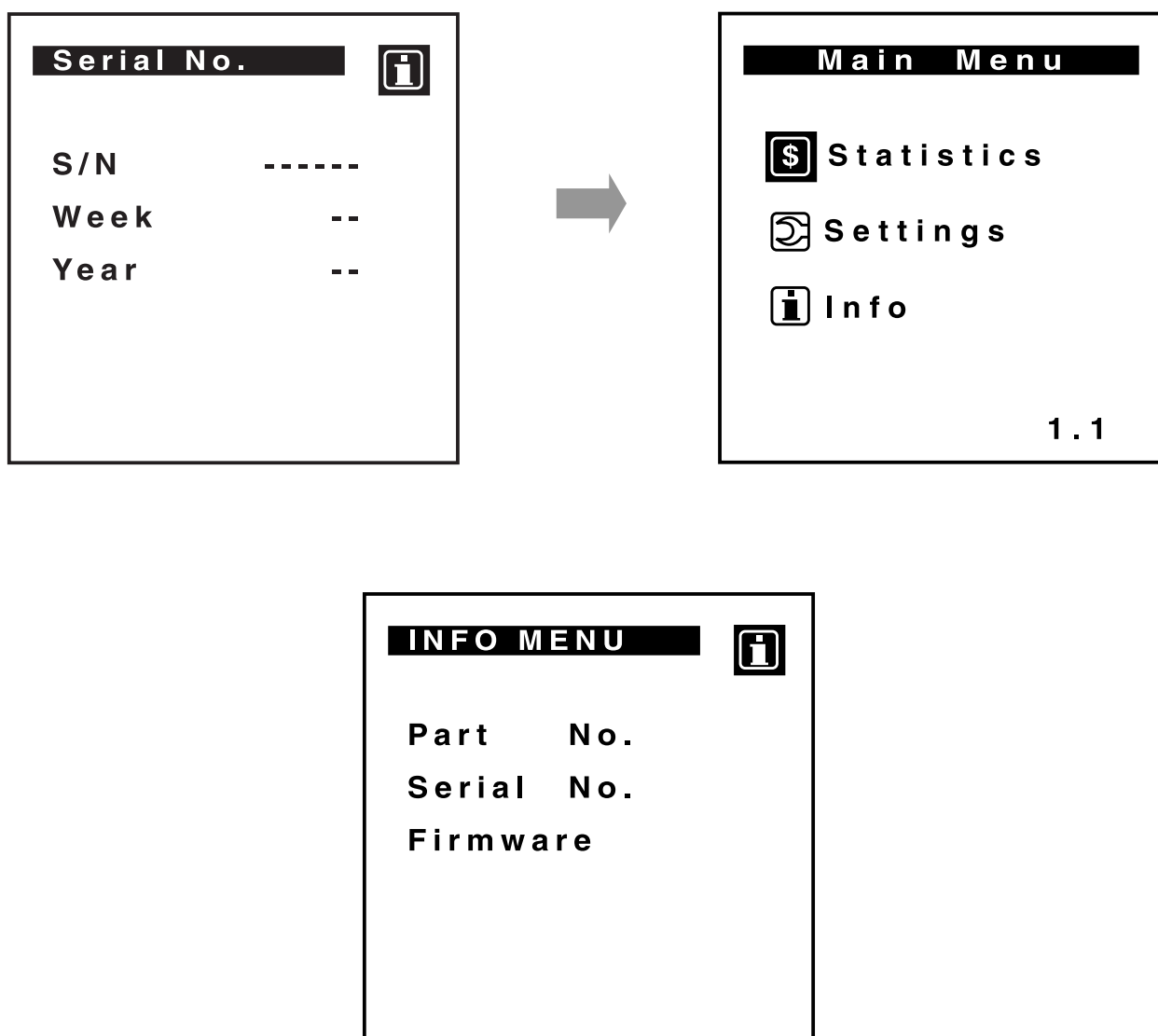

A summary diagram of the display functions is shown in the figure below:

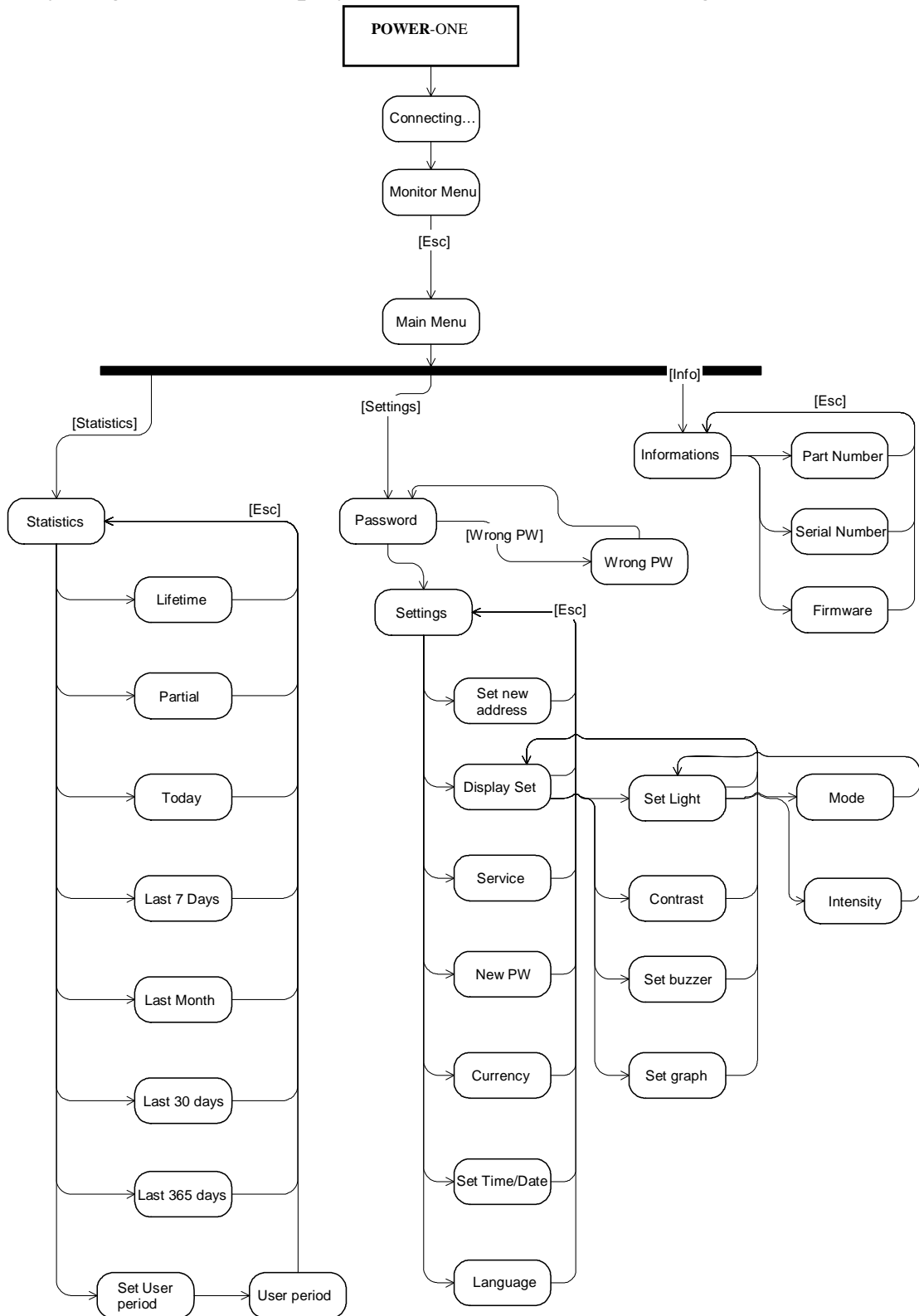

## **6 DATA CHECK AND COMMUNICATION**

AURORA is able to transmit the measured data and the error and warning messages through 2 communication devices as illustrated in Fig. 15.

These devices are the RS-485 and the RS-232 serial ports, both available on this model of AURORA.

The other devices are optional and can be added to AURORA by inserting the appropriate communication boards in the slots located under the removable cover.

## 6.1 RS-232 and RS-485 serial link

The RS-232 and RS-485 serial ports both refer to the same communication hardware and therefore, may not be used simultaneously.

The RS-232 serial port allows the connection between one single inverter and a PC using a 9-pole serial wire available in the shops. The serial connector is a female DB-9 type and is located in the bottom of the unit close to the display (Fig. 15).

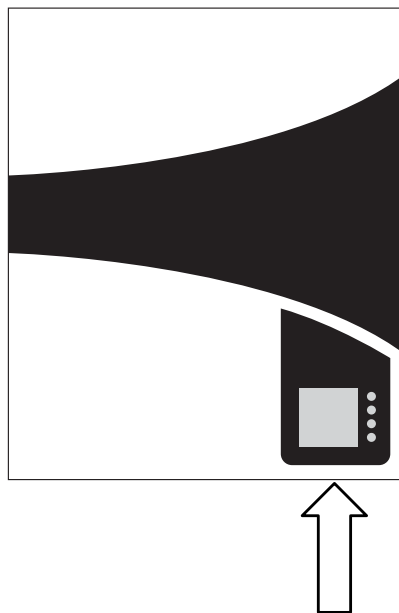

Fig. 15 Position of the DB-9 connector

The RS-485 serial port uses two wires for signals plus a third wire for signal grounding. The wire must be inserted in the wire gland provided, which must be mounted at the bottom of the unit, instead of the watertight cap as shown in Fig. 16. To make the installation easier, a 2-hole seal for wire gland is also provided to run two wires in case more units are connected together as described below. If the installer prefers to use this kind of seal and only one wire is used, we recommend closing the unused hole with the plastic cap provided.

The wires are then run to the RS-485 screw terminal blocks and connected as shown in Fig.17

- Signal wires must be connected to +T/R and –T/R terminals
- Grounding wire must be connected to the RTN terminal



Fig.16: RS-485 wiring

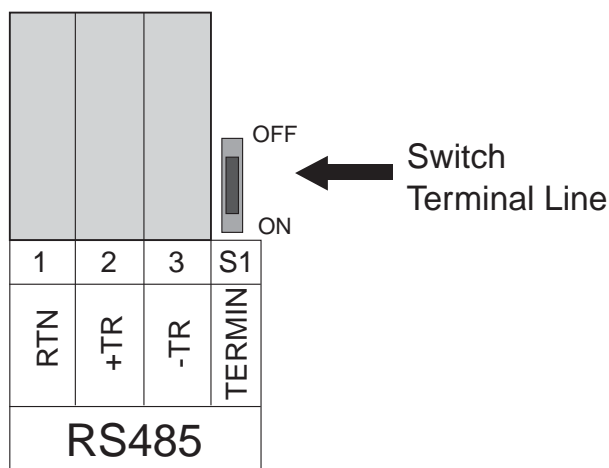

Fig. 17 RS-485 serial link terminal blocks

The RS-485 serial port can be used to connect a single AURORA inverter or more inverters connected together daisy-chain style. The maximum number of inverters than can be connected daisy-chain style is 31. The maximum length recommended for the RS-485 wire is 1200 metres.

In the event of multiple inverters connected daisy-chain style, you must assign an address to each unit. Moreover, the last inverter of the chain must have the line termination contact activated (dip-switch S1 in Fig.17 must be taken to the ON position).

By default each AURORA has address two (2) and the S1 dip switch is in the OFF position.

The following diagram shows how to connect multiple units daisy-chain style.

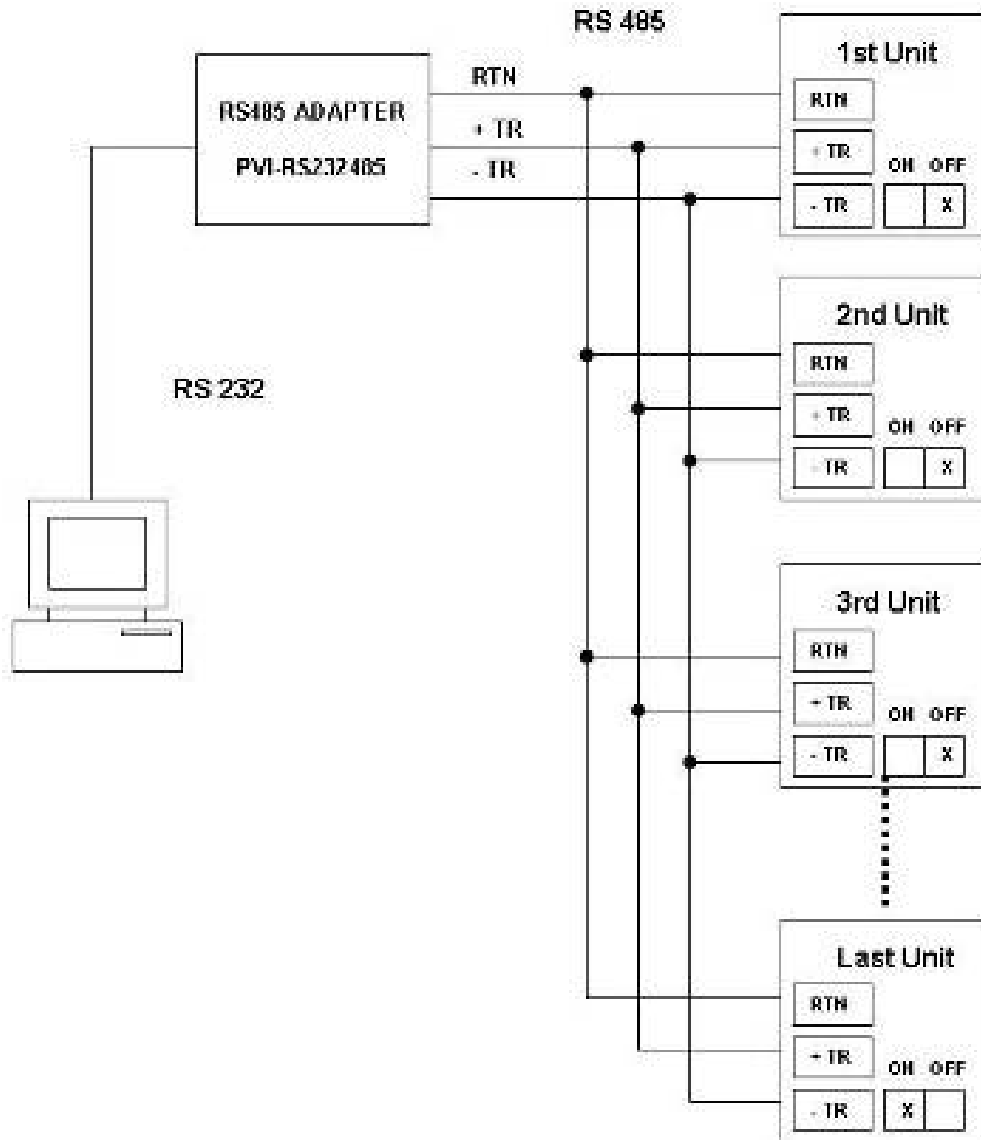



Fig.18 Multiple units connection daisy-chain style

 **NOTE:** When using the RS-485 link there can be no more than 31 inverters connected on the same link. Although you are free to choose any address between 2 and 63, we recommend using addresses between 2 and 34 for the RS-485 serial link.

 **NOTE** When using the RS-485 link, in case one or more inverters are later added to the system; please remember to bring the dip switch that was the last of the system back to OFF.

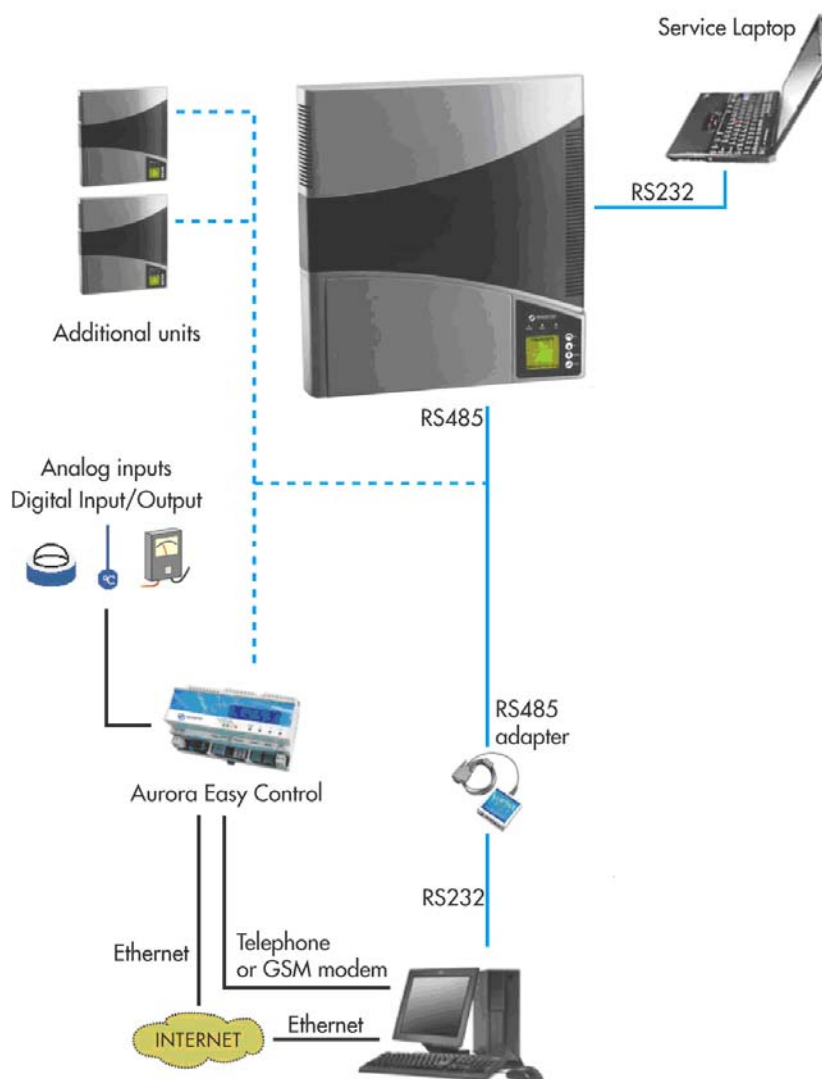

Fig.19: Data communications to AURORA Easy Control

## 6.2 Address selection

When several inverters are connected to the same communication channel each unit must have a different address. The default address of each unit is 2. To assign a new address the following information must be taken into account:

- Addresses 0 and 1: are reserved for host computers and monitoring accessories such as Easy Controller display unit.
- The RS-485 serial link uses addresses from 2 to 34



**NOTE:** To modify the address of the unit please refer to paragraph 5.5.2 “Settings menu”.



### 6.3 Measurement Accuracy

Every measurement device can be affected by errors.

For each measurement the tables below show the following information:

- Measurement Unit;
- Delivery rate;
- Resolution.

	Data	Unit	Resolution		Max error
			Display	Measurement	
Output voltage PV N°1	VP1	Vdc	1 V	1/1000	2%
Output voltage PV N°2	VP2	Vdc	1 V	1/1000	2%
Output current PV N°1	IP1	Adc	0.1 A	1/1000	2%
Output current PV N°2	IP2	Adc	0.1 A	1/1000	2%
Power PV N°1	Pin1	W	1 W	1/1000	2%
Power PV N°2	Pin2	W	1 W	1/1000	2%
Output voltage	Vout	V	1 V	1/1000	2%
Output current	Iout	A	0.1 A	1/1000	2%
Output power	Pout	W	1 W	1/1000	2%
Frequency	Freq	Hz	-	-	-
External temperature	Temp	°C	-	-	-

Isolation resistance	Riso	$\Omega$	-	-	-
Grid impedance	Imped	$\Omega$	-	-	-
Energy produced	Energy	Wh	1 Wh		-
Tot. time counter	Lifetime	hh:mm:ss	1 s		-
Partial time counter	Partial Time	hh:mm:ss	1 s		-

## 7 TROUBLESHOOTING

AURORA inverters comply with standards set for grid-tied operation, safety and electromagnetic compatibility.

Before being delivered by Power-One, the product has undergone successfully to several tests to check: operation, protective devices, performance and durability.

All these tests, together with the system ensuring Power-One quality, guarantee an optimal operation of AURORA.

However, should any malfunction of the photovoltaic system arise, solve problems as follows:

- ✓ Work under safe conditions as stated in chapter 3.5 and following. Make sure that the connections between AURORA, the photovoltaic field and power distribution grid have been made correctly.
- ✓ Carefully observe which LED is blinking and read the signal appearing on the display; then, following the instructions given in chapters 5.4 and 5.5 try to identify the type of fault found.

If the malfunction cannot be removed by following these instructions, contact the service centre or the installer (see following page).

---

Before contacting the service centre, keep the following information close at hand, to maximise efficiency of intervention:

### **AURORA INFO**



**NOTE:** Information to be found directly on the LCD display

- ✓ AURORA model?
  - ✓ Serial number?
  - ✓ Week of production?
  - ✓ LED flashing?
  - ✓ Light blinking or steady?
  - ✓ Which signal is shown on the display?
- 
- ✓ Short description of the malfunction
  - ✓ Can the malfunction be reproduced?
  - ✓ If so, how?
  - ✓ Does the malfunction appear cyclically?
  - ✓ If so, how frequently?
  - ✓ Is malfunction present from installation?
  - ✓ If so, has it worsened?
  - ✓ Description of the weather conditions at the time the malfunction appeared

### **INFO on the Photovoltaic Field**

- ✓ Make and model of photovoltaic panels
- ✓ System structure:
  - number of arrays and max. voltage and current values
  - number of strings for each array
  - number of panels for each string

---

## 8 TECHNICAL FEATURES

### 8.1 Input Values



**WARNING:** the Photovoltaic field and system wiring must be configured so that the PV input voltage is less than the maximum upper limit independently from the type, the number and the operating conditions of the chosen photovoltaic panels.

As panel voltage also depends on working temperature, the number of panels per string shall be chosen according to the min. ambient temperature expected in that special area (see table A).



**WARNING:** The inverter has a linear power derating related to the input voltage, starting from 530 Vdc (100% output power) to 580 Vdc (0% output power)



**WARNING:** The open circuit voltage of the photovoltaic panels is affected by the ambient temperature (the open circuit voltage increases as the temperature decreases). Make sure that at the minimum temperature estimated for the installation does not cause the panels to exceed the maximum upper limit of 600Vdc. As an example, the following table shows for typical panels of 36, 48 and 72 cells, the maximum voltage of each panel as function of the temperature (assuming a nominal open circuit voltage of 0.65Vdc at 25°C and a temperature coefficient of 0,0023V/°C). The table shows, therefore, the maximum number of panels that can be connected in series as a function of the minimum temperature at which the system will operate. Consult the panel manufacturer for the correct temperature coefficient of  $V_{oc}$ , before calculating the voltage rating of the photovoltaic array.

Minimum Panel Temp.[°C]	36 Cells Panels		48 Cells Panels		72 Cells Panels	
	Panel voltage	Max number of panels	Panel voltage	Max number of panels	Panel voltage	Max number of panels
25	21.6	27	28.8	20	43.2	13
20	22.0	27	29.4	20	44.0	13
15	22.4	26	29.9	20	44.9	13
10	22.8	26	30.5	19	45.7	13
5	23.3	25	31.0	19	46.5	12
0	23.7	25	31.6	19	47.3	12
-5	24.1	24	32.1	18	48.2	12
-10	24.5	24	32.7	18	49.0	12
-15	24.9	24	33.2	18	49.8	12
-20	25.3	23	33.8	17	50.7	11
-25	25.7	23	34.3	17	51.5	11

Table A

<b>Description</b>	<b>Value PVI - 2000</b>
Nominal input voltage	360Vdc
Input voltage range	from 90 Vdc to 600 Vdc
Input voltage, MPPT operating range	from 90 Vdc to 580 Vdc
Input voltage, MPPT range at full power	from 165 Vdc to 530 Vdc
Minimum input voltage for grid connection	200Vdc
Max. short circuit current	12 Adc
Max. operating input current	10 Adc
Max. input power	2200 W
PV Ground fault protection	Ground fault detection and shut off provided
Array configuration	One array



**NOTE:** If the input current supplied by the photovoltaic field connected to the inverter is above the max. value and the input voltage is within the allowed range, the inverter is not damaged.

## 8.2 Output Values

<b>Description</b>	<b>Value PVI – 2000</b>
Nominal output power	2000 W
Grid voltage maximum range	from 200 to 270 Vac
Nominal grid voltage	230 Vac
Grid voltage, operating range in compliance to AS4777	from 89% to 115% of nominal voltage (from 205 to 264Vac for $V_{nom}=230Vac$ )
Grid frequency, maximum range	from 45 to 55 Hz
Grid frequency, nominal	50 Hz
Grid frequency, operating range in compliance to AS4777	from 47.1 to 52.9 Hz
Current output, nominal	9 Arms
Output over current protection	11 Arms



### 8.3 Grid protection characteristics

Anti islanding protection	In compliance to: - AS4777.3-2005
---------------------------	--------------------------------------

### 8.4 General characteristics

Description	Value PVI - 2000
Maximum efficiency	> 95%
Internal consumption during stand-by	< 8 W
Internal consumption during night time	< 0.30 W
Operating ambient temperature	from -25°C to +55°C (from -13°F to 131°F)
Enclosure protection level	IP21 / Nema 2
Audible Noise	< 30dBA @ 1m with fans off < 50 dBA @ 1m with fans max speed
Dimensions (H x W x D):	440 x 465 x 57 mm
Weight	6 kg

## 8.5 Power Derating

To ensure a safe operation of the inverter under any temperature and electrical condition, the unit will automatically derate the power to be supplied to the grid. Power derating can occur on one of the following occasions:

### Power Derating due to Ambient Temperature

Aurora is equipped with internal high reliability fans with electronically controlled speed in order to keep the internal component within the optimal operating temperature range.

When the ambient temperature is particularly high, the unit, even if the fans are at maximum speed, may need to reduce the power supplied. The level of the power derating and the temperature at which the derating starts are influenced by the ambient temperature and also by several other parameters, such as input voltage, grid voltage, input power available from the PV panels.

At typical operating conditions with nominal input voltage at 360Vdc and nominal output voltage 230Vac, supposing that from the PV field a sufficient power to guarantee a max. output power of 2000W is available, in reference to the graph in Fig.20, the following applies:

- For ambient temperatures below 20°C there is no power derating while fans are off.
- For ambient temperatures between 20°C and 25°C there is no power derating while the fans are being activated. However, it is not necessary to maintain the fans on permanently, therefore they are turned on and off according to the requirements.
- For ambient temperatures between 25°C and 40°C there is no power derating while the fans are on at a speed depending on the temperature.
- For ambient temperatures between 40°C and 55°C there could be a power derating, even with the fans at max speed, up to reaching at 55°C a minimum output power of 1600W.

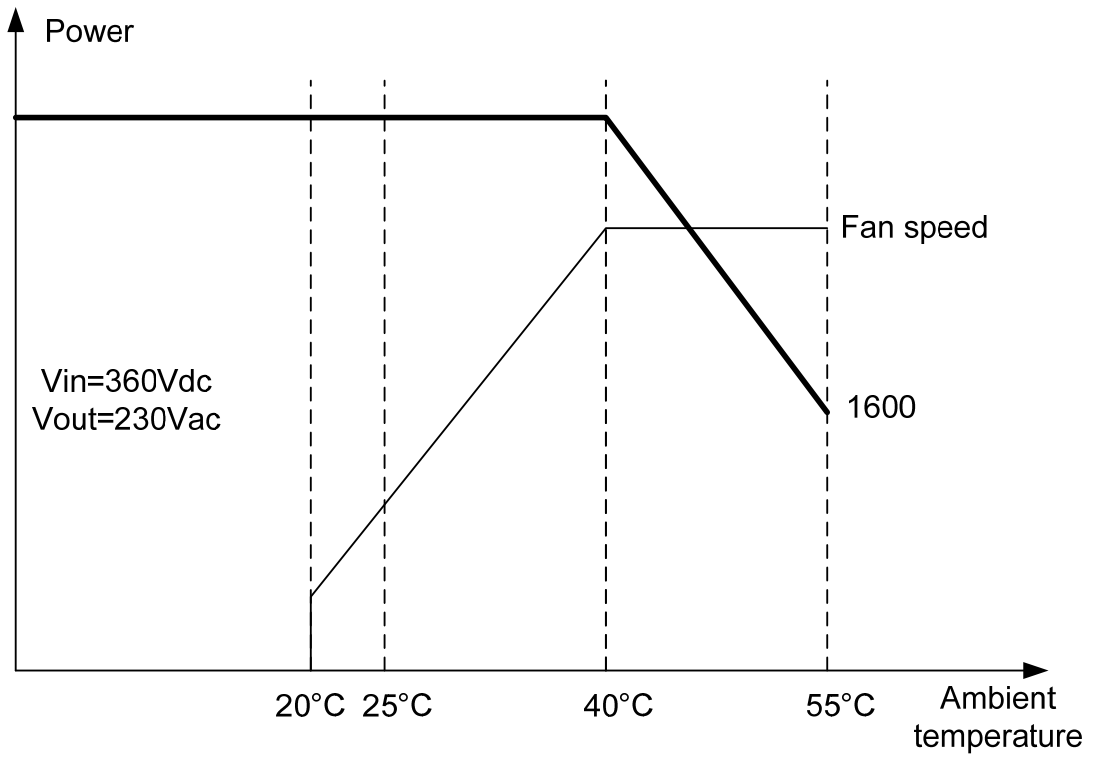

Fig. 20

### Power Derating due to Input Voltage

The graph shows the automatic derating of the power supplied when input voltage values are too high or too low.

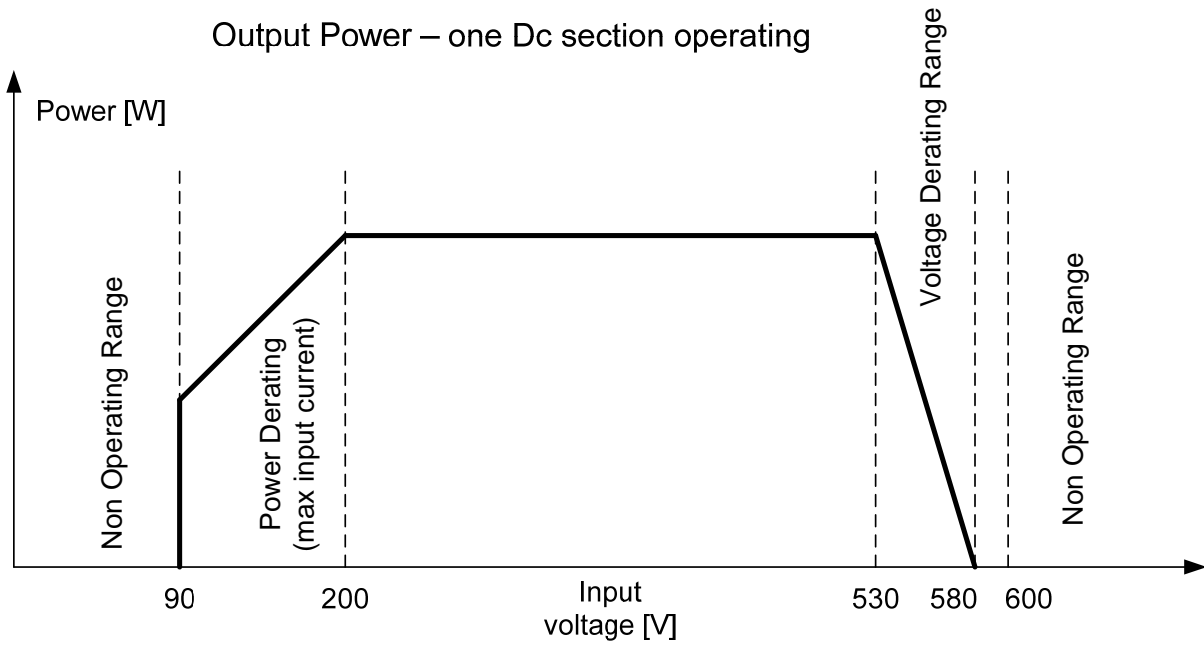

Fig. 21

\*\*\*\*\* CERTIFICATES OF COMPLIANCE \*\*\*\*\*